

내 주변에는

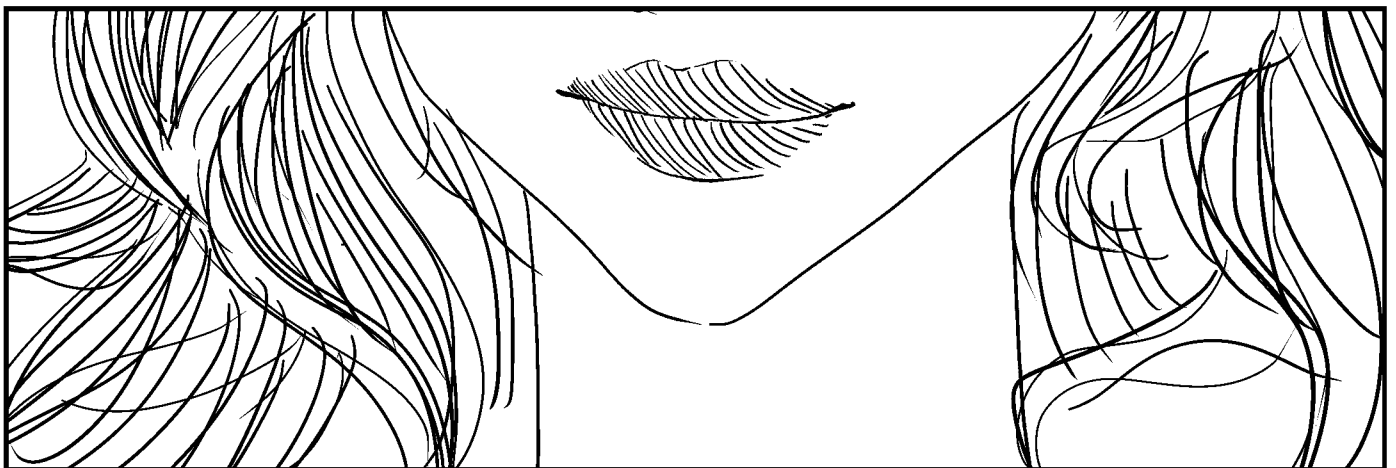

코르셋적인 요소가



정말 많았다.



항상 거울을 보면서
자신의 얼굴 상태를
확인한다.



미디어 매체로 보는
'예쁜 사람'을
부러워하고



화장하고

예뻐지기 위해서

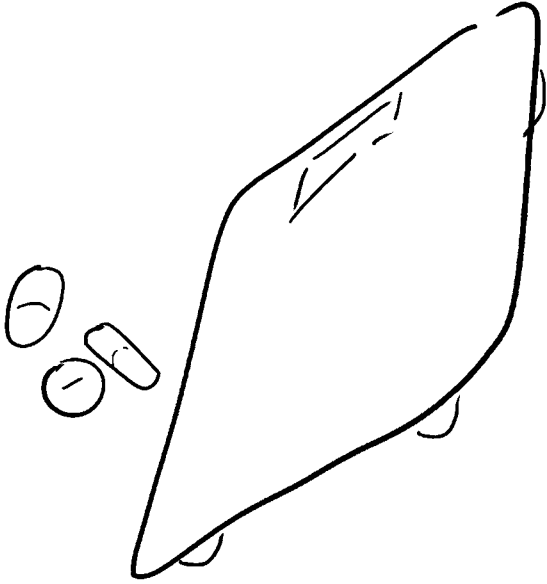

살을 뺀다.

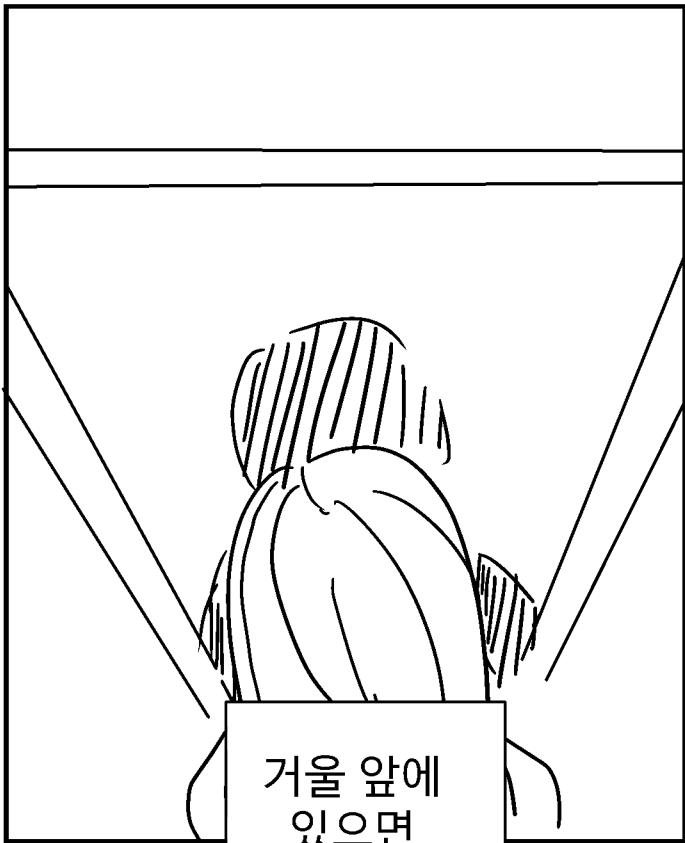

거울 앞에
있으면

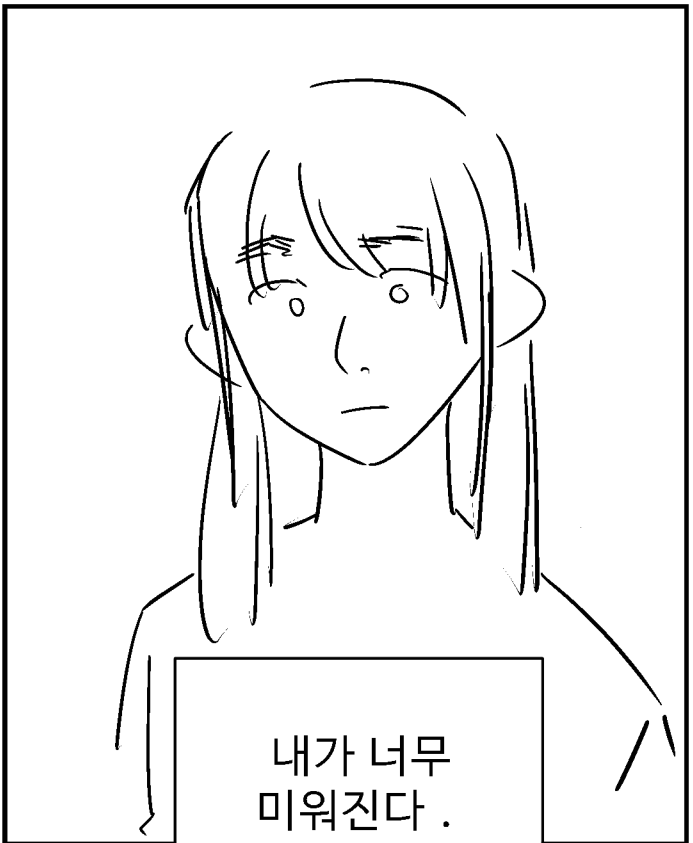

내가 너무
미워진다 .

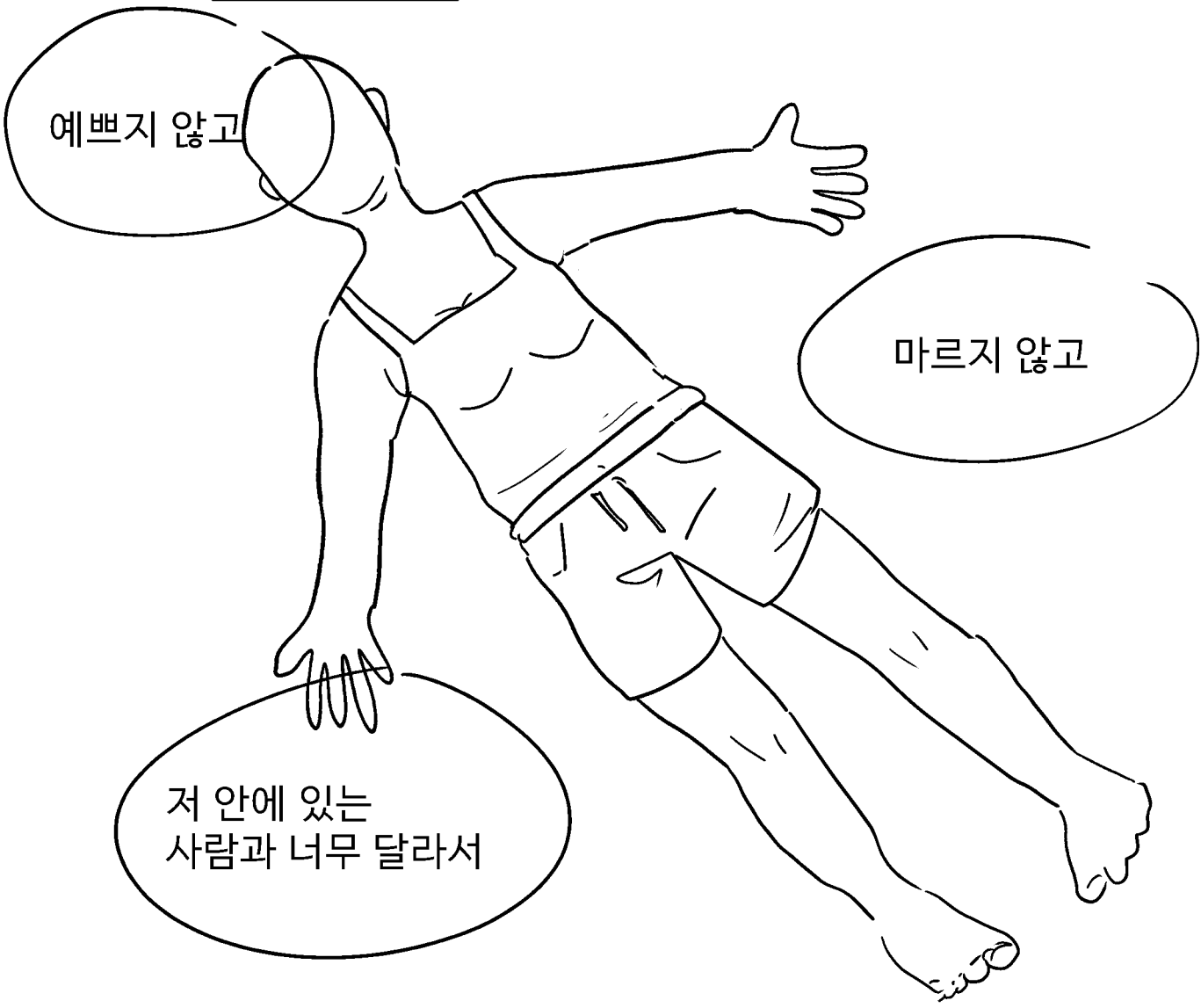

예쁘지 않고

마르지 않고

저 안에 있는
사람과 너무 달라서



' 나도 저렇게 되고 싶어! '

라는 욕망은



나 말고도 많은
사람들이 가져본
욕망일 것이다.



여성은 ' 예뻐야 한다 ' 는
메세지를 어디서나
받는다 .

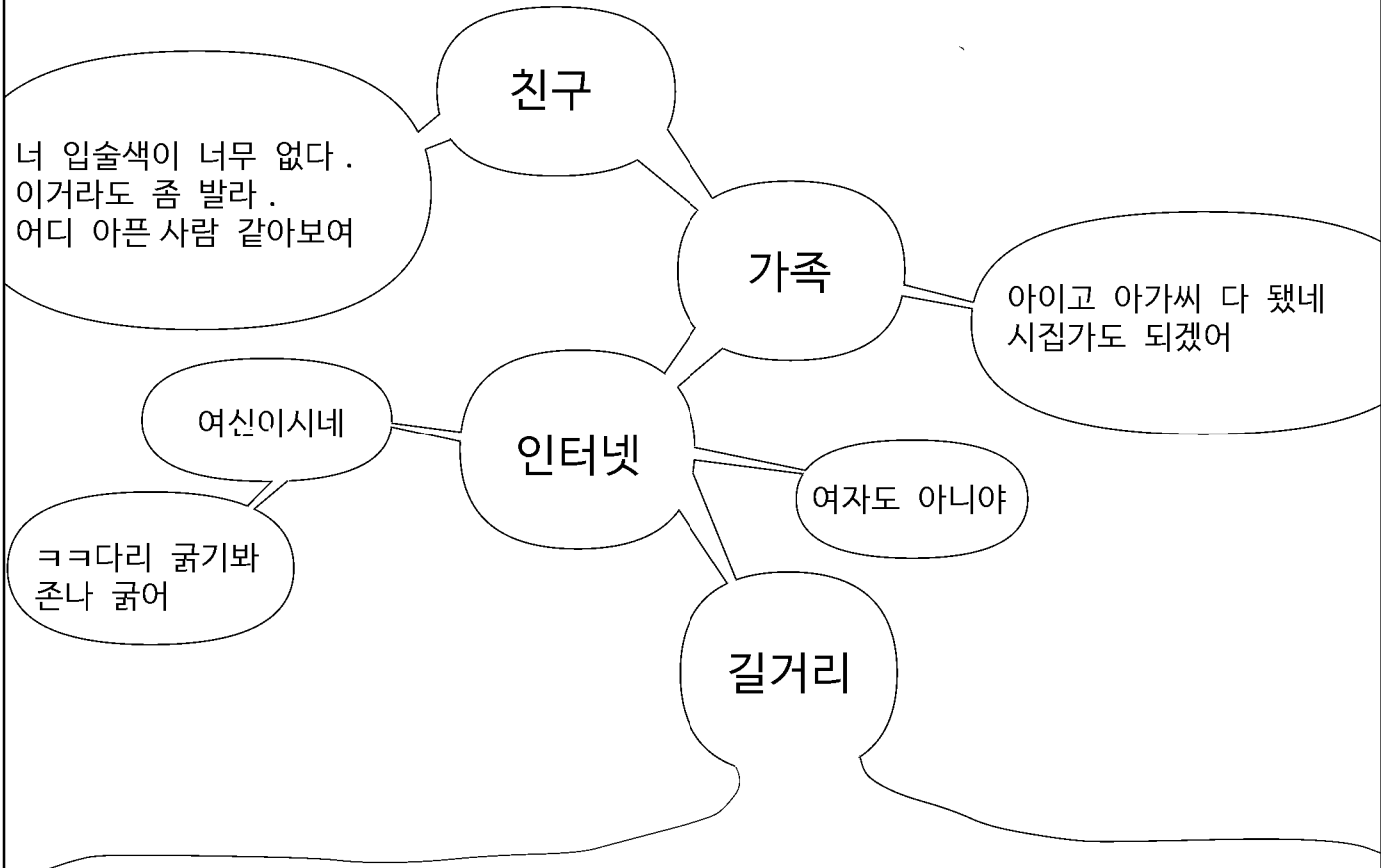

내가 이상한건가?





다리가 얇지
않으면 여성답지
않은 것인가?

얼굴이 가름한 게
예쁜거라고?

아 , , 어떡해

나는 얼굴도 동그랗고

몸에 살도 많고



코도 넓대대한
복코야

내 살을 잡아서

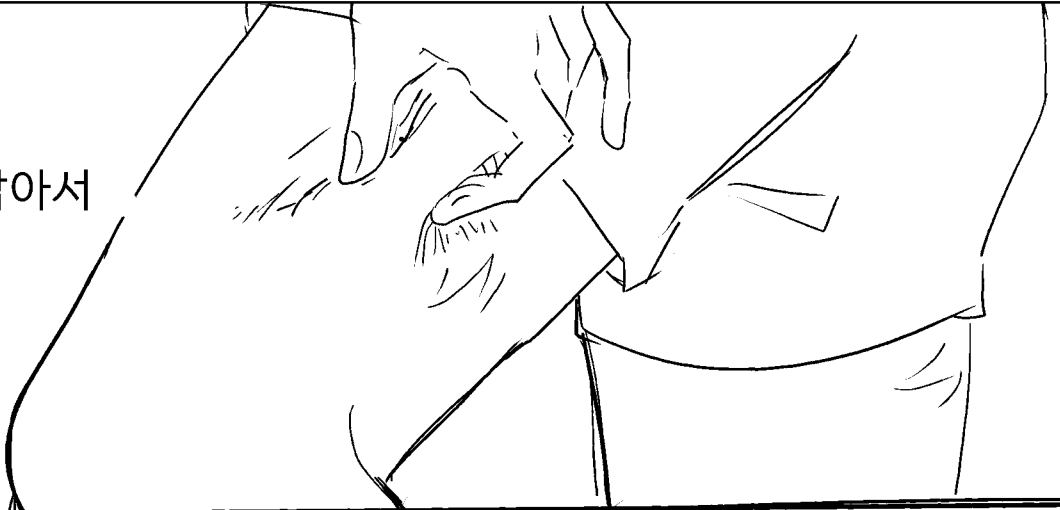

칼로 도려내면



얇은 다리가 될 수
있지 않을까 라는



말도 안되는 상상을
해 본 적도 있다.

예뻐지고 싶다 .

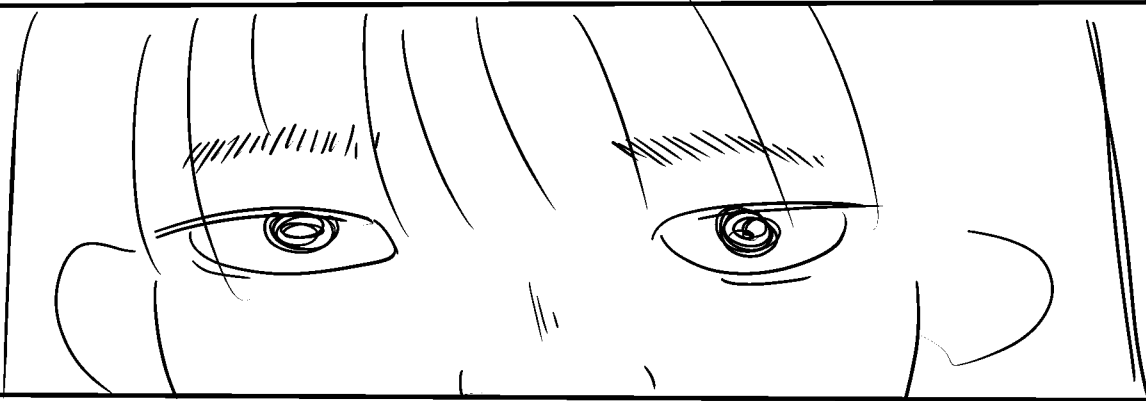

밋밋한 눈이 더 또렷해지면 좋겠다 .



코가 더 뾰족했으면 좋겠다 .

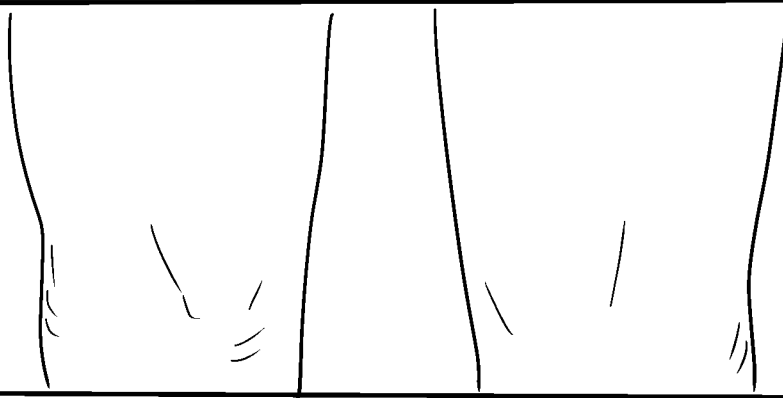

다리가 더 얇아지면 좋겠다 .

내가

너무

싫어진다 .

' 나는 왜 이렇게 생겼을까 '
라고 생각하면서



내가 싫어지는 게 싫다 .

뚱뚱해지는 날 미워하는
것이 싫어진다 .



밥을 적게 먹는 것이
가벼운 기분이라고 생각하는
것이 싫다 .

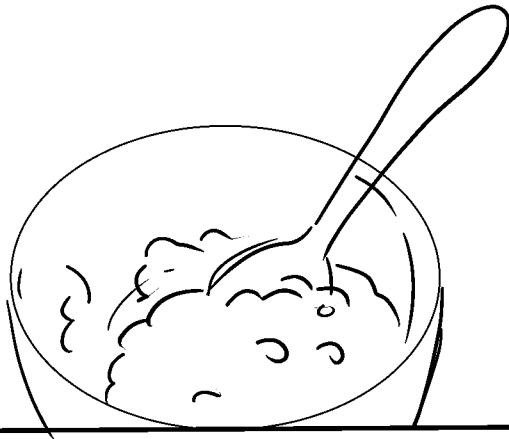

남을 평가하는 말을
칭찬하는 말로 포장하는
것이 싫다 .

양쪽 세팅하거라?



여름이 되면 겨드랑이 털이
보일까 싶어 털을 미는 게
싫다 .

못생긴 사람을 보았을 때
뒤에서 비웃는 것이 불편하다 .

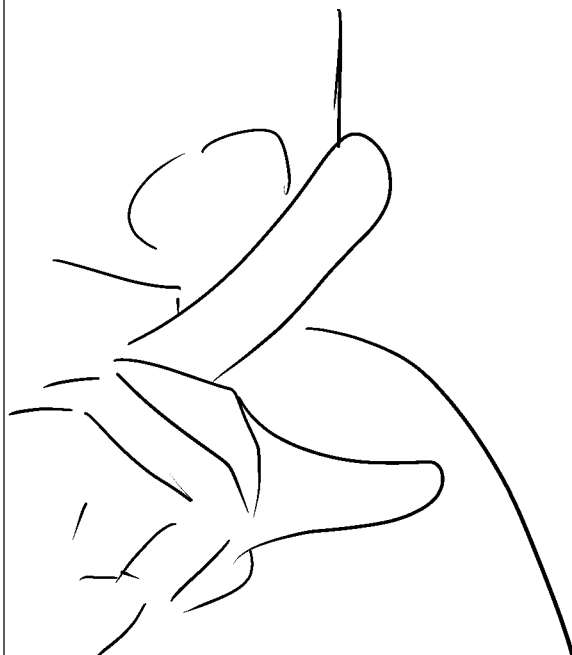
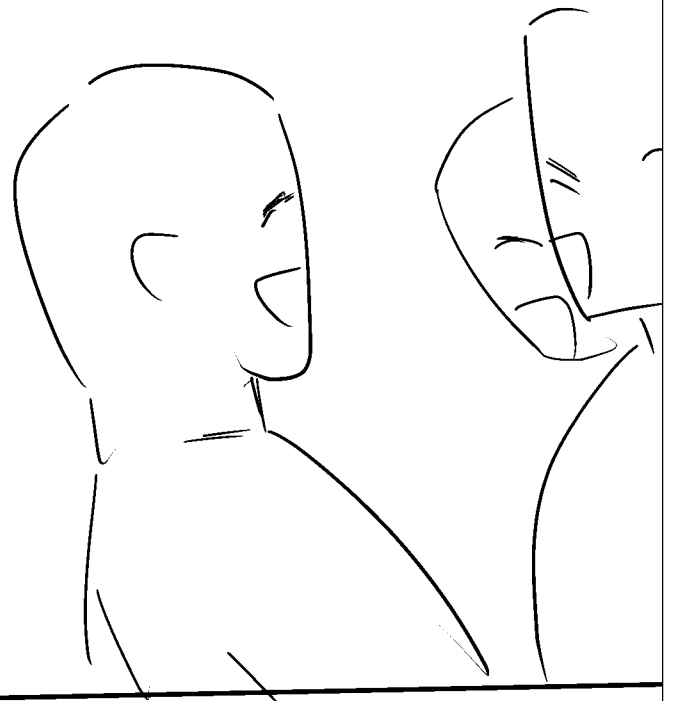

화장하지 않는 것을
지적받는 것이 싫다 .

머리 좀 길러 , ,
남자애 같아

그만 좀 쳐먹어라

페미년 ㅋㅋ

살 좀 빼라

시집은 갈 수
있겠니?

남자친구는
생기겠냐?

여자가 여리
여리 한 맛이
좀 있어야지

내가 저 몸으로
태어났으면 자살함

ㅋ =

메갈쿵광 ㅋㅋ

저게 사람이냐?

와 옆구리 튼살 ㄹ스ㄷ

돼지년

사랑스러워

예뻐라

인형 아니야?

우리 자기가
최고야

이슬만 먹고
살았어?

존예...

언니 완전
제 워너비

자기야 너무
예뻐,

언니ㅠㅠ 너무
예뻐요ㅠㅠ

어머~ 누구딸이래~?
너무 예쁘다

우리 딸이에요.
예쁘죠? ㅎㅎ

전화번호 한번만
알려주시면 안돼요?
제 번호는 010...

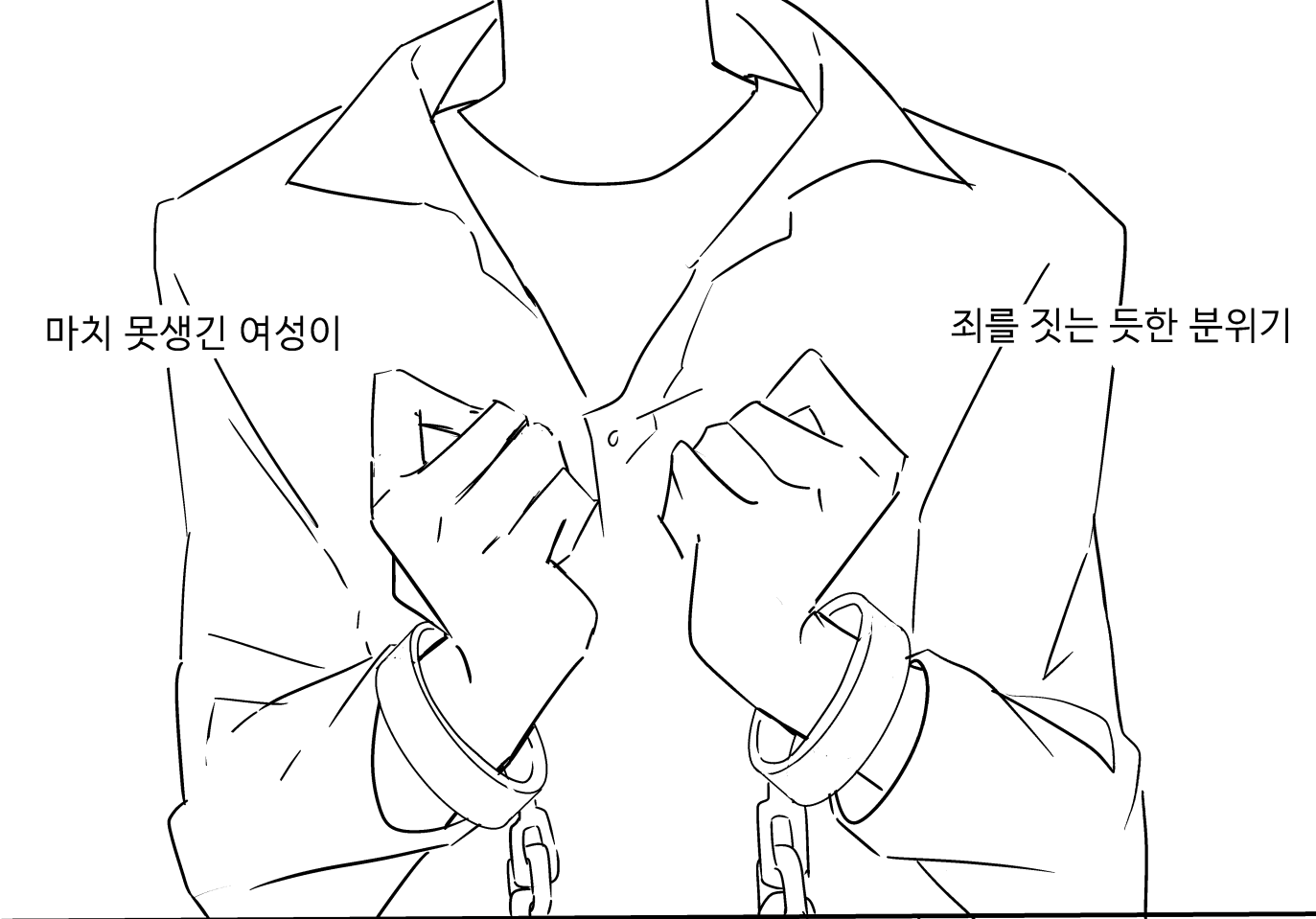

마치 못생긴 여성이

죄를 짓는 듯한 분위기



예뻐야만 여자로 인정받는다.

나는 항상 '예뻐져야 한다'고
듣는다.

화장하여 예뻐지면

예뻐질수록



원래의 나를

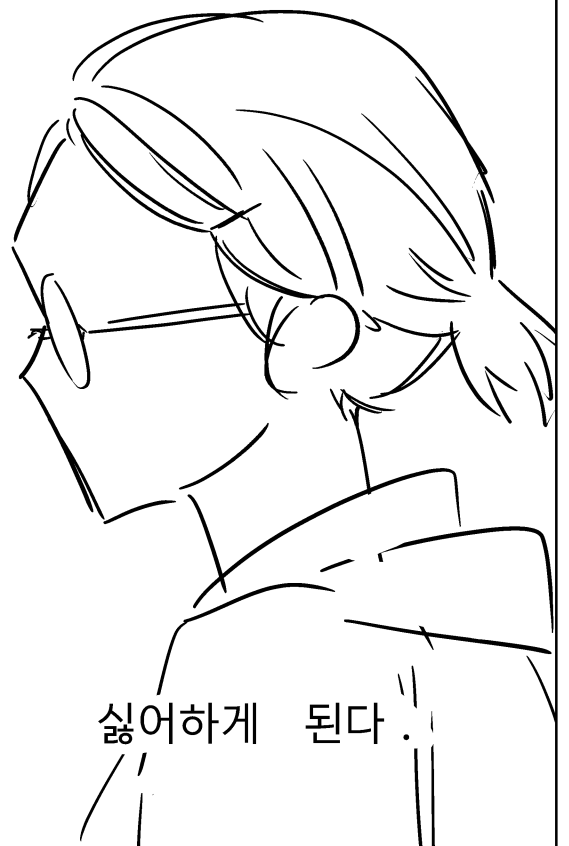

싫어하게 된다.

자꾸만 바비 인형이
되려 한다.

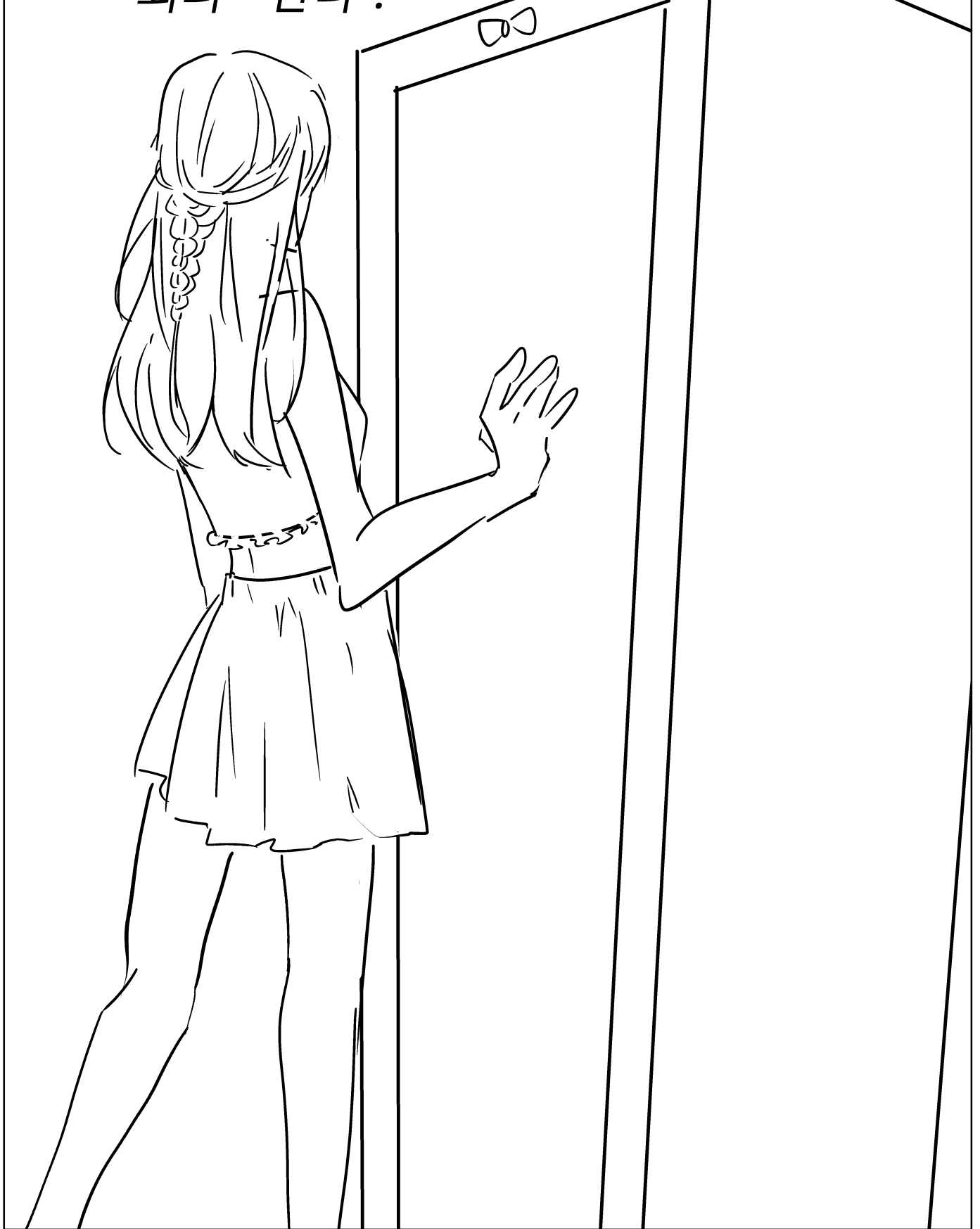

여성에게 필수적으로 강요되는 꾸밈 .

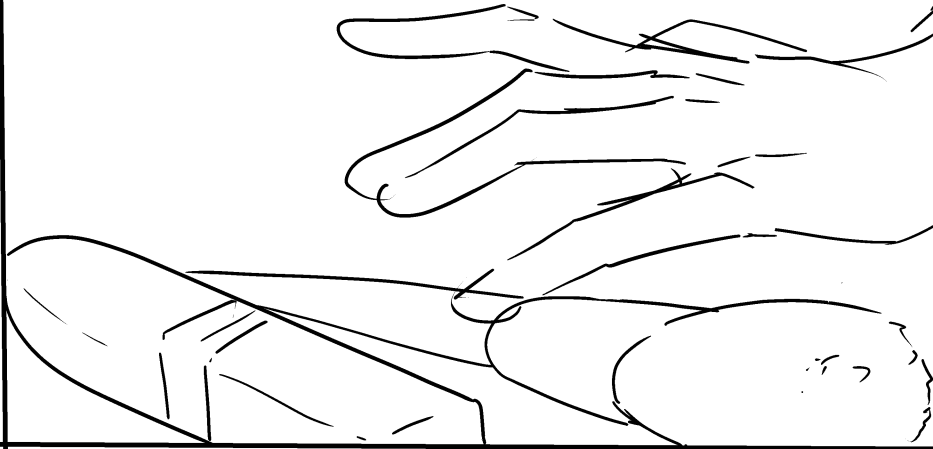

그 꾸밈을 강하게 거부한다 .



더 멀어지려 노력한다



나는 왜 바비인형이
되어야만 하지?



왜 사람이
인형 취급을 받아야해?





여성은 오래전부터
외모와 신체적인
평가를 받아왔다 .

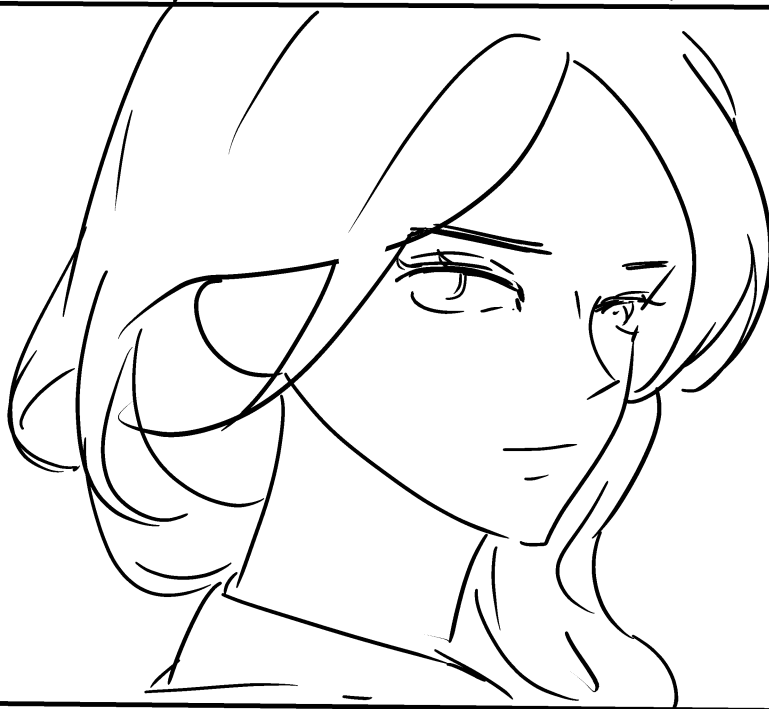

외모의 기준은



계속해서 바뀌었다 .

인터넷이 활성화 되면서

여쁨의 기준은

좁아지고

좁아지고

좁아졌다.

예쁨의

가치는 점점
높아질수록

나의 가치는

점점 떨어진다 .

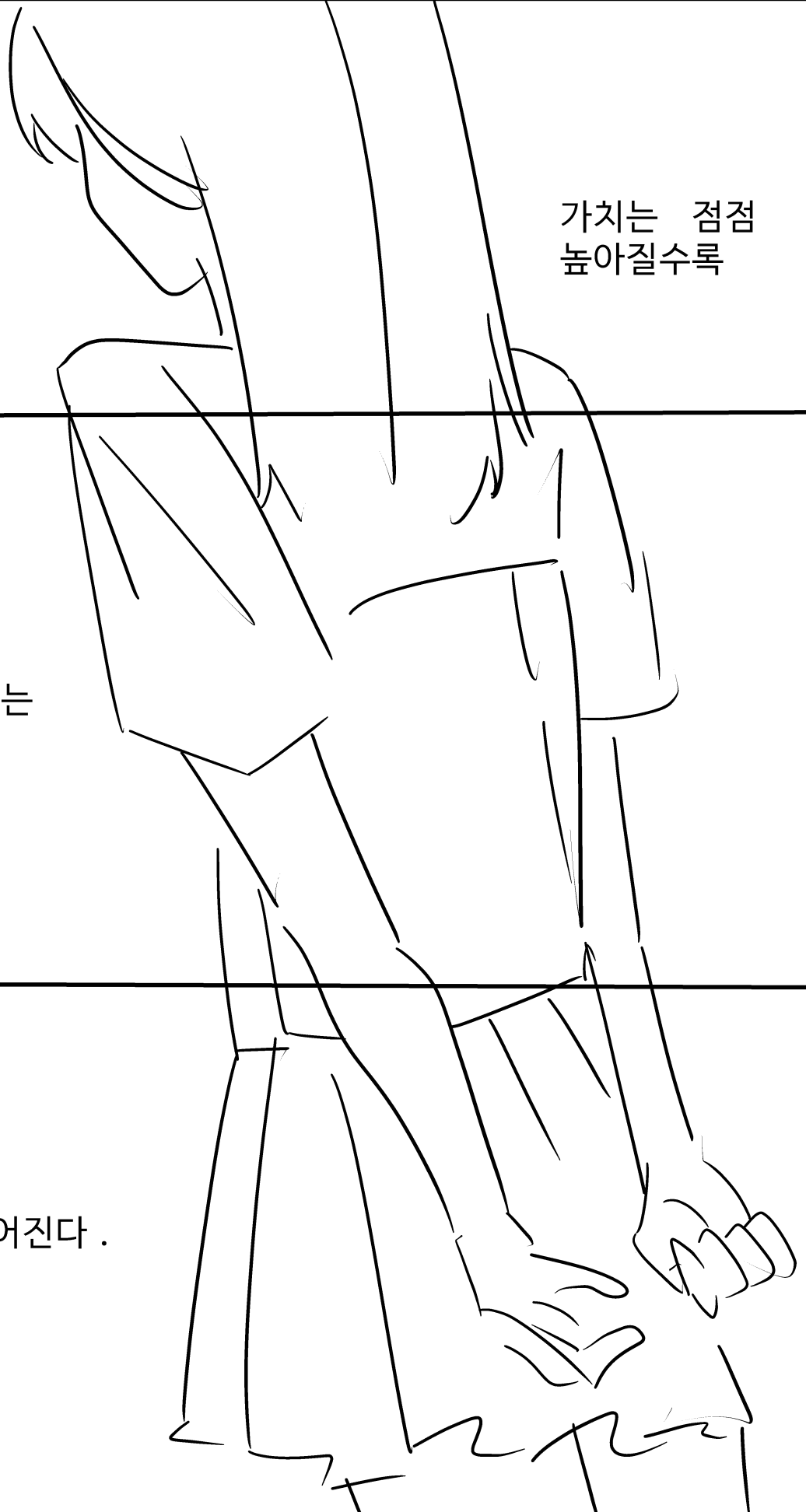

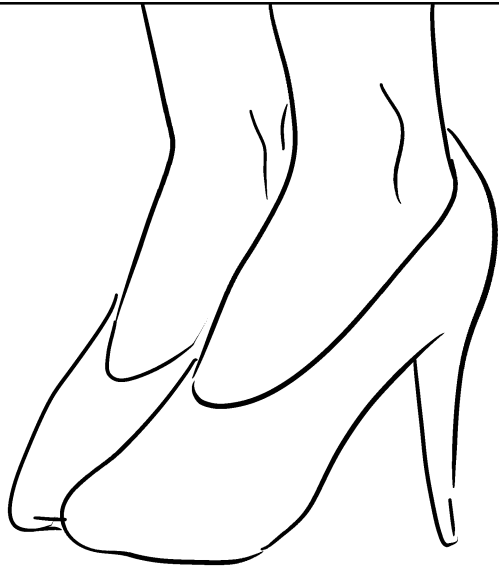

내가 하이힐을 신고
싫어해서 신는 것인지

살을 빼고 싶어해서
뺨 것인지

이 모습이 내가
원하는 모습이
맞는지

나는 너가 코르셋을
차지 않았으면 좋겠다 .

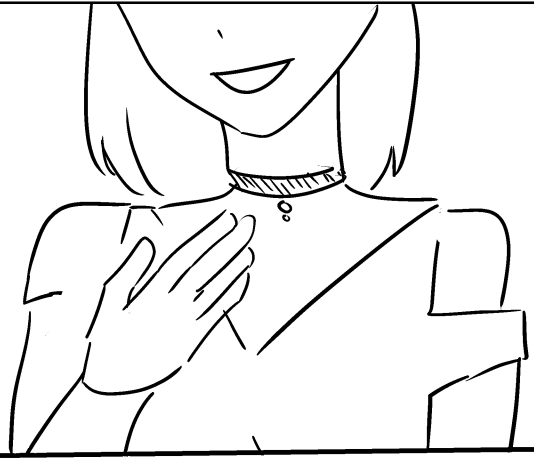

여성은 .

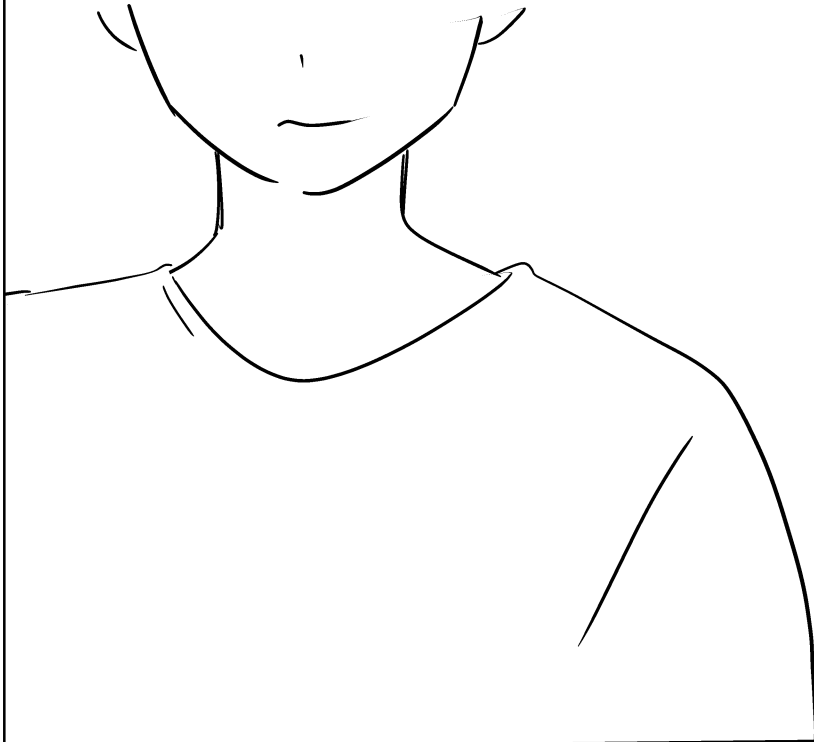

코르셋을 차야만 하는걸까 ?



코르셋은 건강하지 않다.

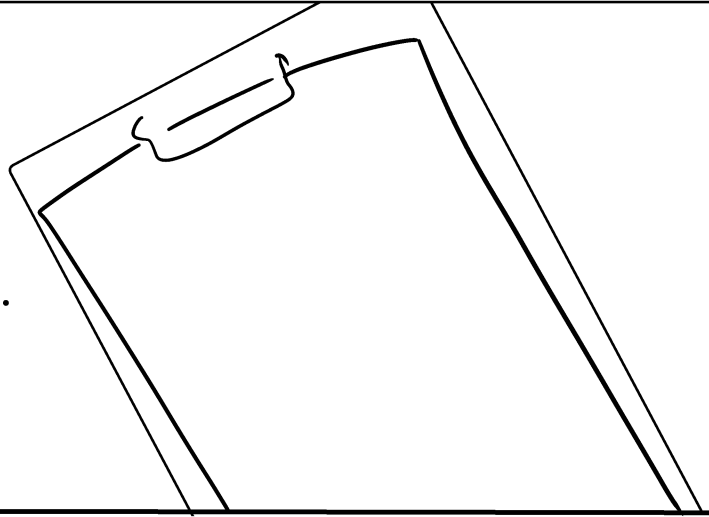

정신적으로도



신체적으로도

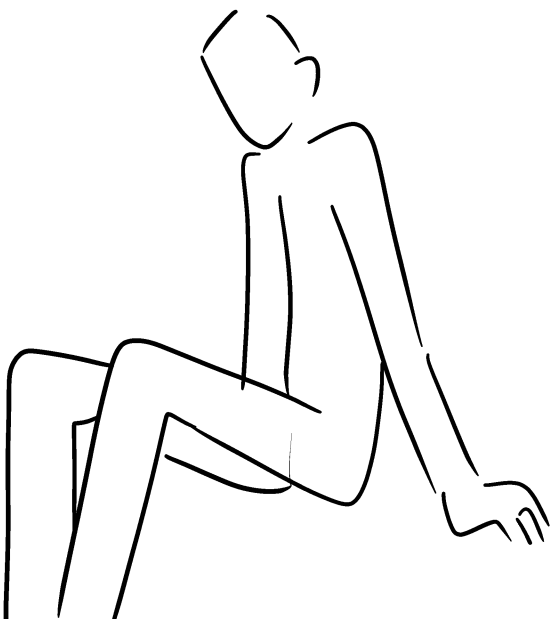

코르셋을 차면
내가 싫어지고



내 몸이 아파진다.



외모를 가꾸어
얻을 수 있는 것이 뭐지?



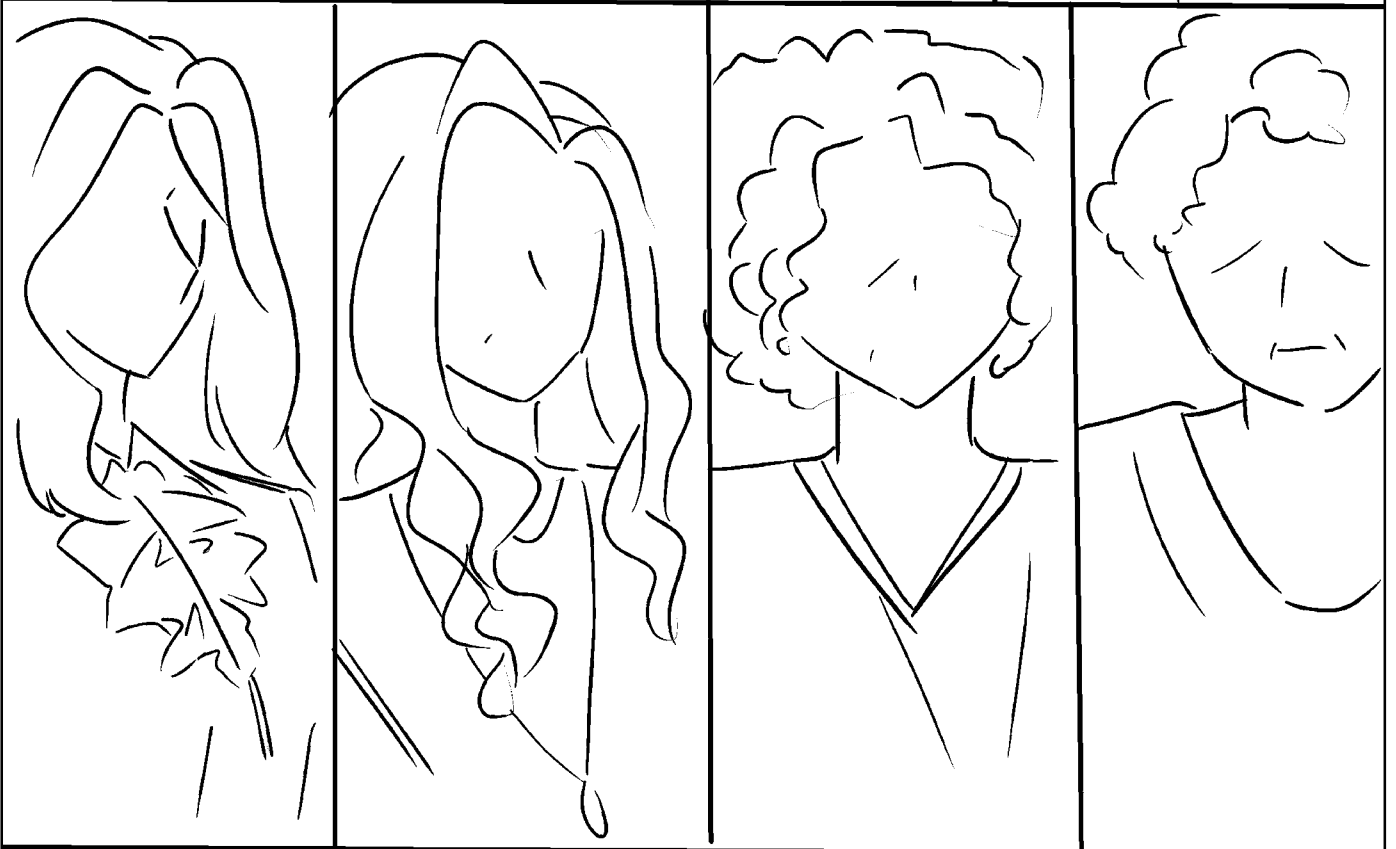

100세 인생 중
코르셋으로 부와 명예를 얻을 수
있는 날은 얼마나 될까

내가 우행해서
꾸미는 거 맞나?

탈코르셋 강요는

그거 안하면 안돼?

꼭 해야해?

그거 탈코 강요야!

그렇게 하지 말라더니

코르셋 강요는



살 좀 빼라

밥 먹듯이 하고 있다.



그렇게까지
할 필요 없어

넌 이대로가 예뻐

지금 모습이 좋다

탈 코르셋을
하려해도
들려오는 이야기가
너무 많다 .

굳이 해야해 ?

남자가 되고
싶은거야 ?

이거 읽어줘서
너무 고마워요 여러분

잘라내고 싶어도
잘라내지 못한다 .



오늘 화장 해?
말아?



안하면 안돼?

그래도 이 꼴로는
못 다니지



하긴, 그렇네



사실은 안하길
바랬다 .



맨 얼굴의 자신을
사랑했으면 좋겠다 .

이런 얘기는 강요이지
않을까 싶어
말하지 못했다 .

세상은 예쁜
사람에게만
친절하다 .

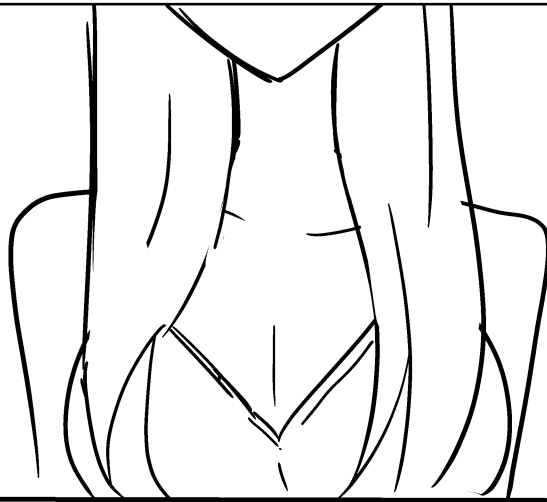

예쁜 사람만
인정해준다 .

자신이 인정받기
위해 잡고 있던
동앗줄은



썩은 동앗줄 이었다 .

그저 ,



여성을 보기 좋은
물건으로 만들기 위한
친절에 불과하다 .

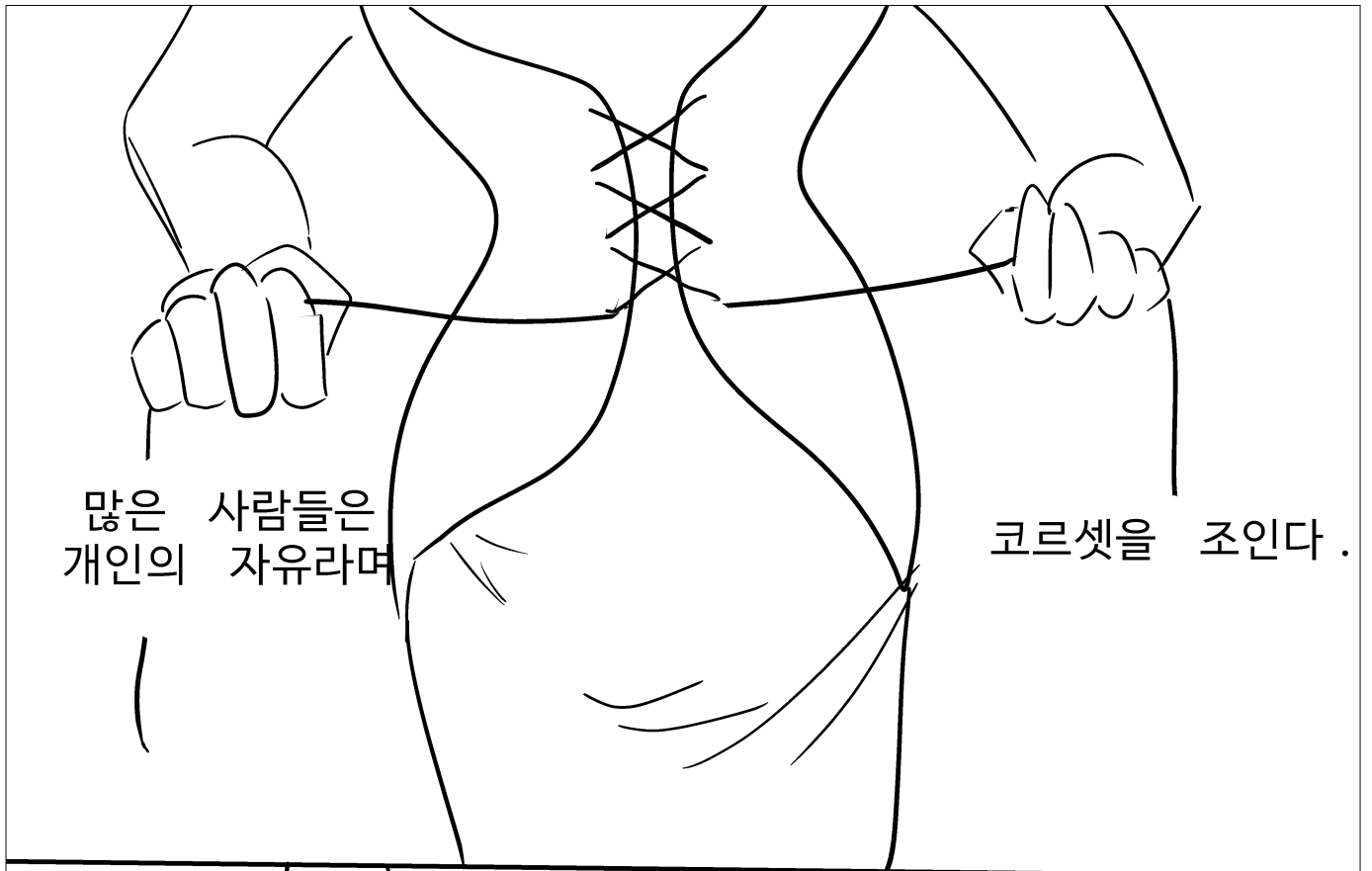

많은 사람들은
개인의 자유라며

코르셋을 조인다.



탈 코르셋은
개인의 자유라도

비난 받는다.

코르셋을 벗고 나면
세상의 친절이 사라진다 .



주변에서 들려오는 말도 많다 .

그래도 난 나를 찾을 수 있었다 .



빡침. .

불쾌했다.

화가 났다.

짜증났다.

당황스러웠다.

기분나빴다.

무서웠다.

수치스러웠다.

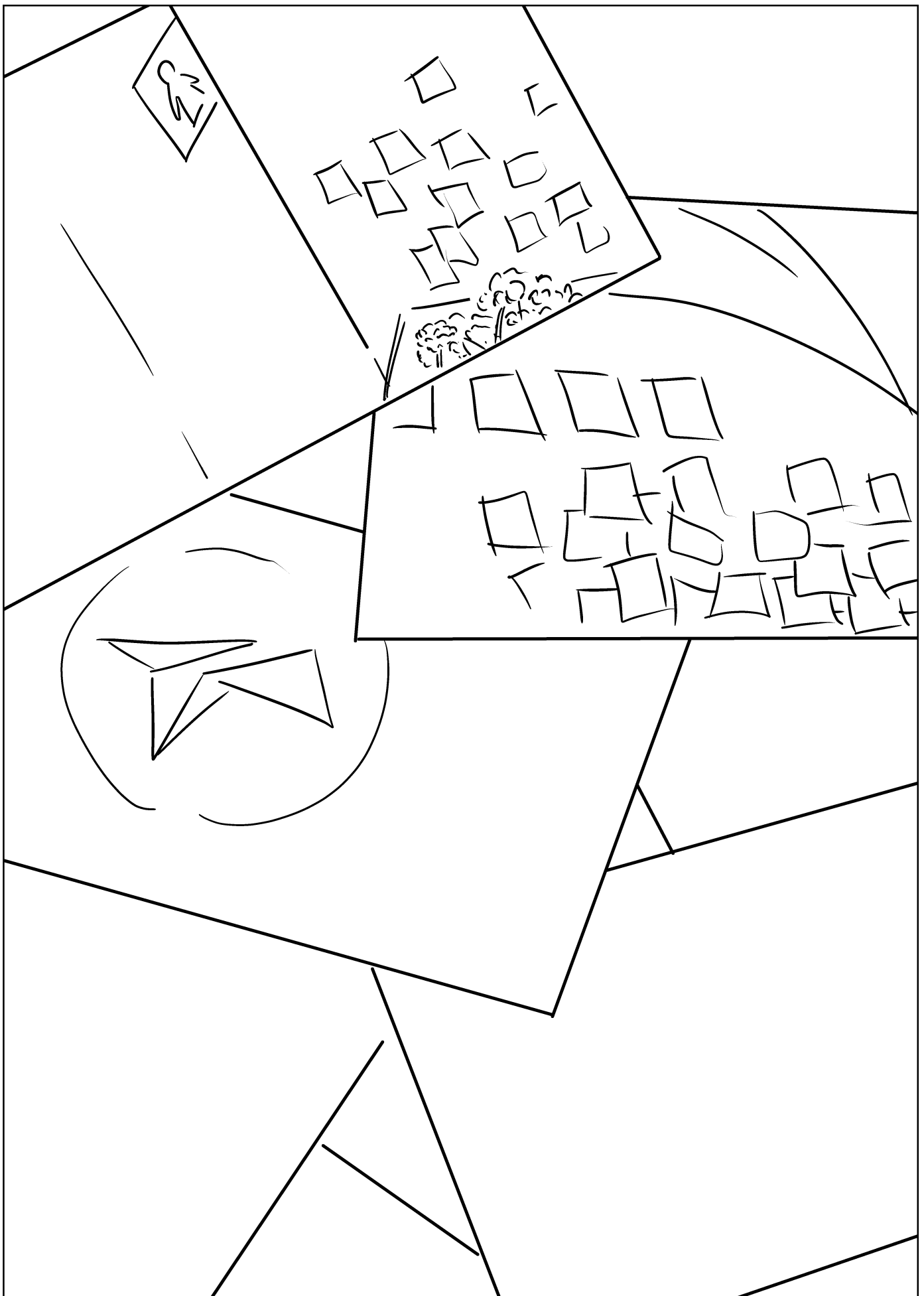

여성혐오로

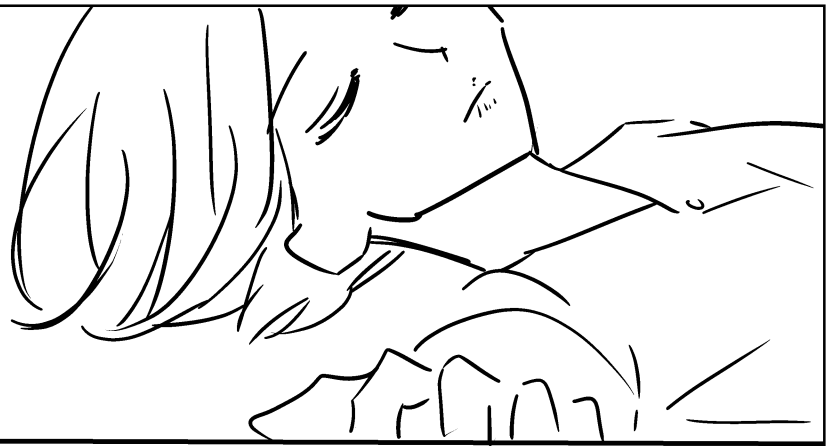

여자가 죽고



여자가 죽고

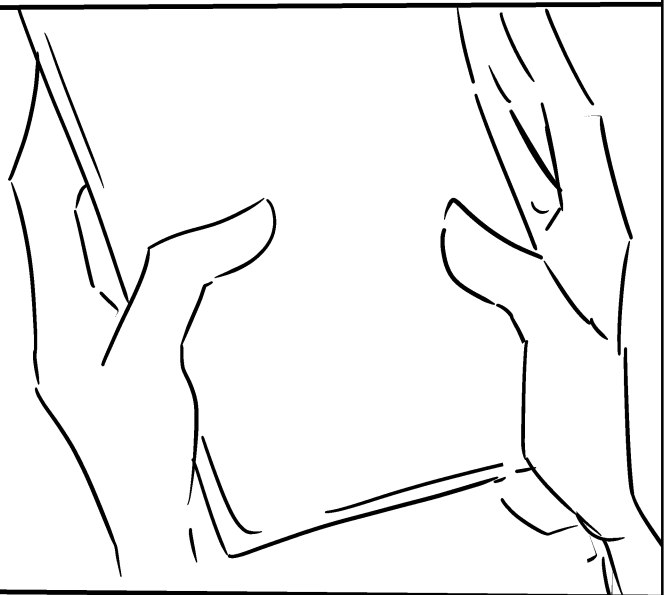

여자가 죽고

왜 여자만 죽지?

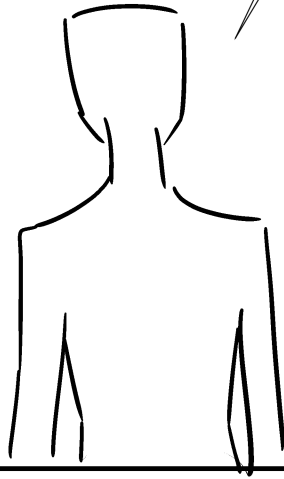

여자가 만만해서?

여자가 약해서?

여자만 죽는 것엔
무슨 이유가 있는거지?

여자가 죽는 사건은
수두룩하다.

여자로 살아가는
것이 이렇게
무서운 것 이었나?

밤에 혼자서 편의점에
갔다오는 것조차



무섭다.

뒤에서 누군가
걸어오는 것 만으로도
심장이 떨린다.

기분탓인지,
내 뒤를 쫓아오는
것 같다.

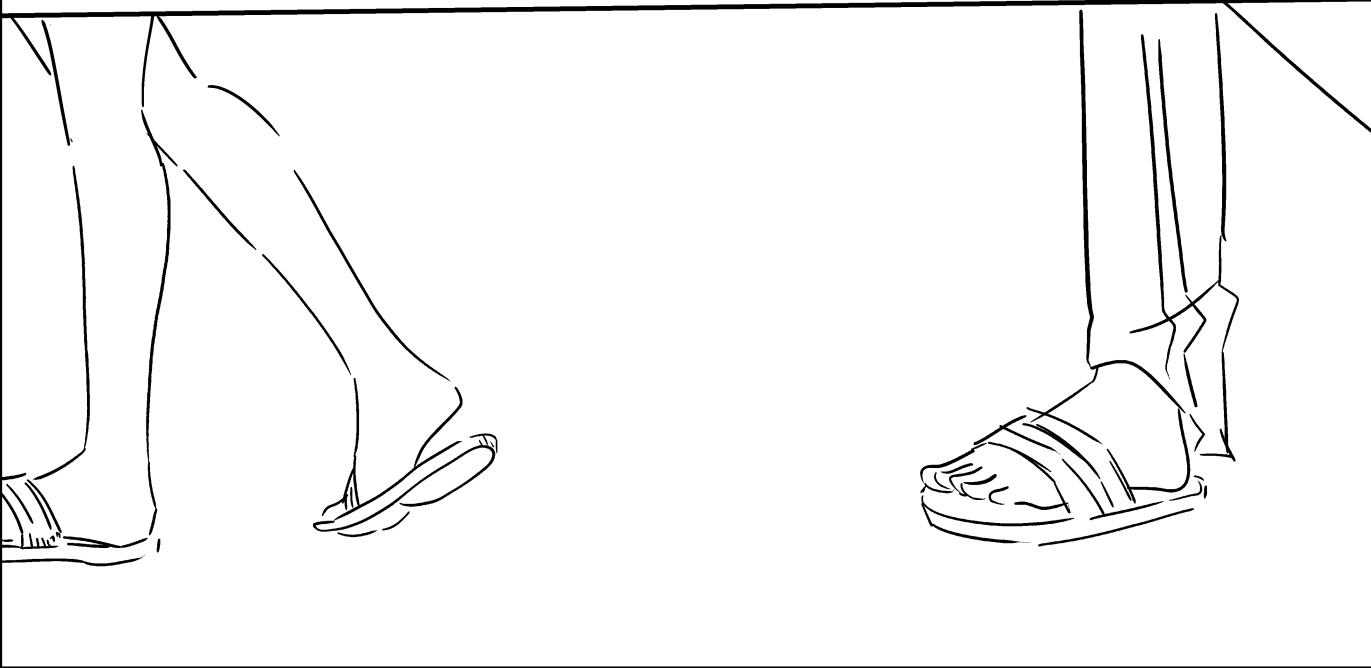
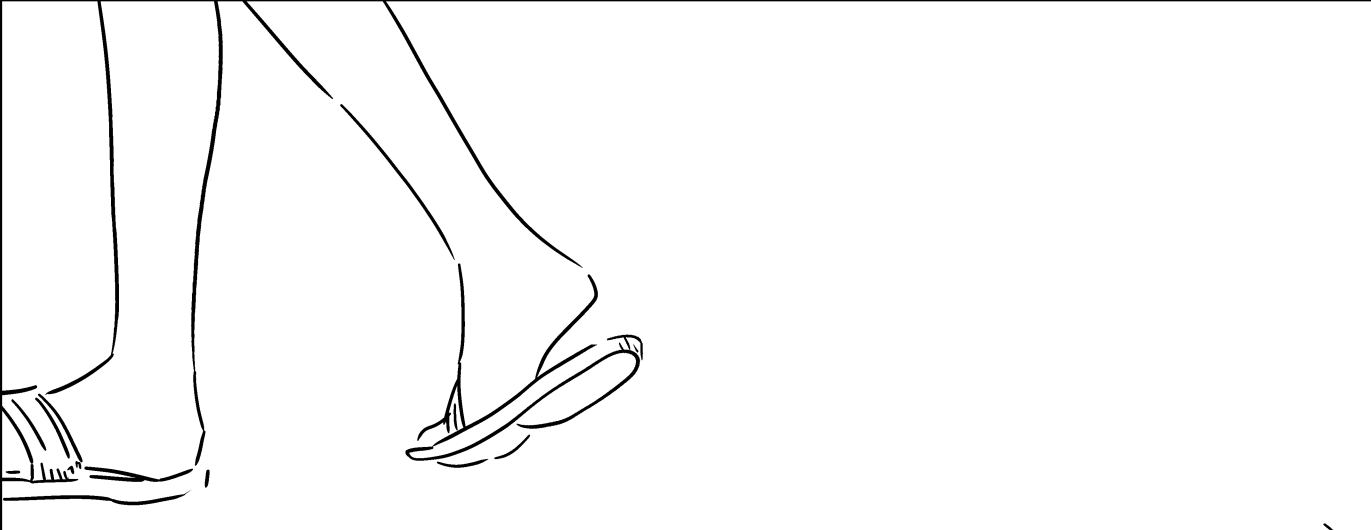

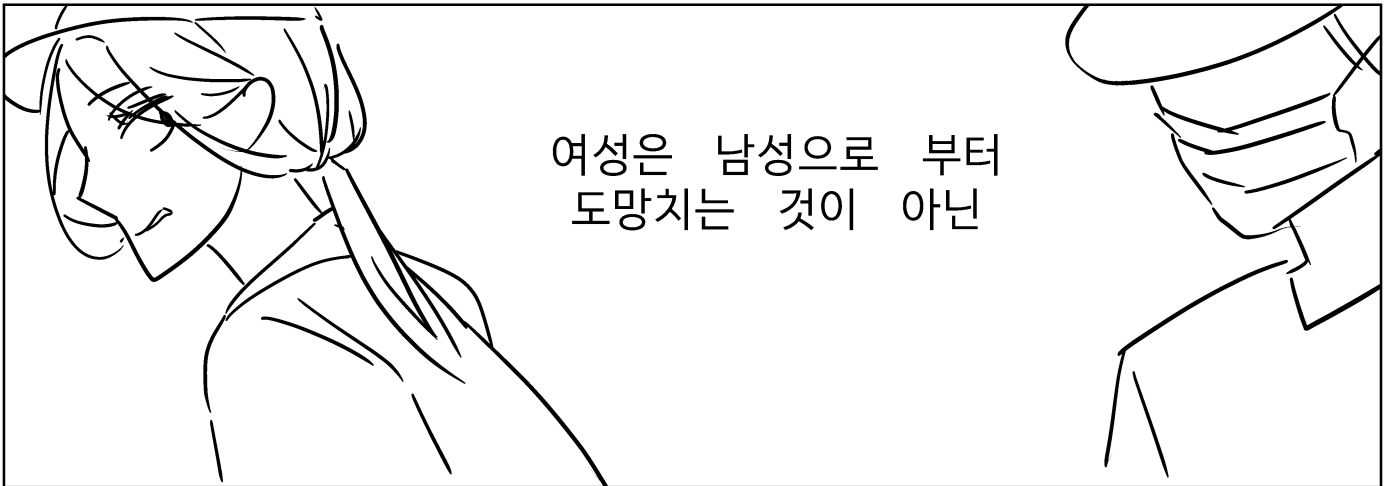

여성은 남성으로 부터
도망치는 것이 아닌

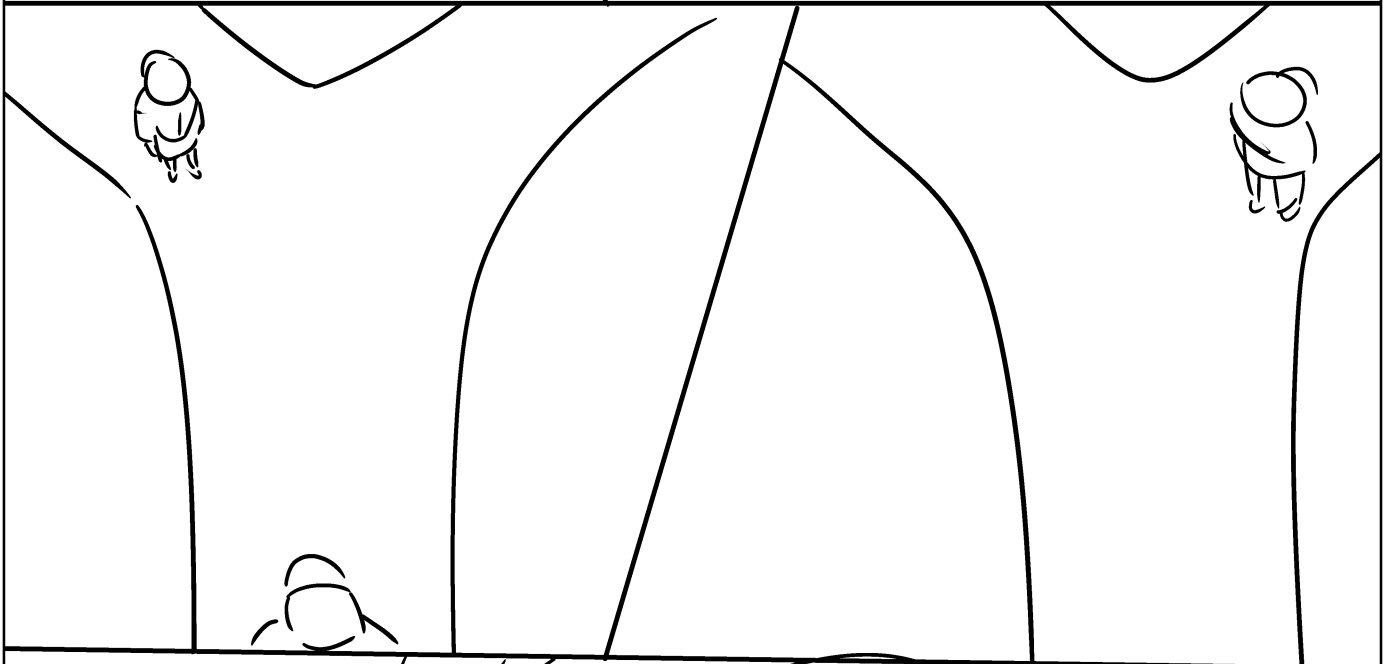

죽음으로부터

도망치는 것이다 .

여성이 무서워 하는 공간

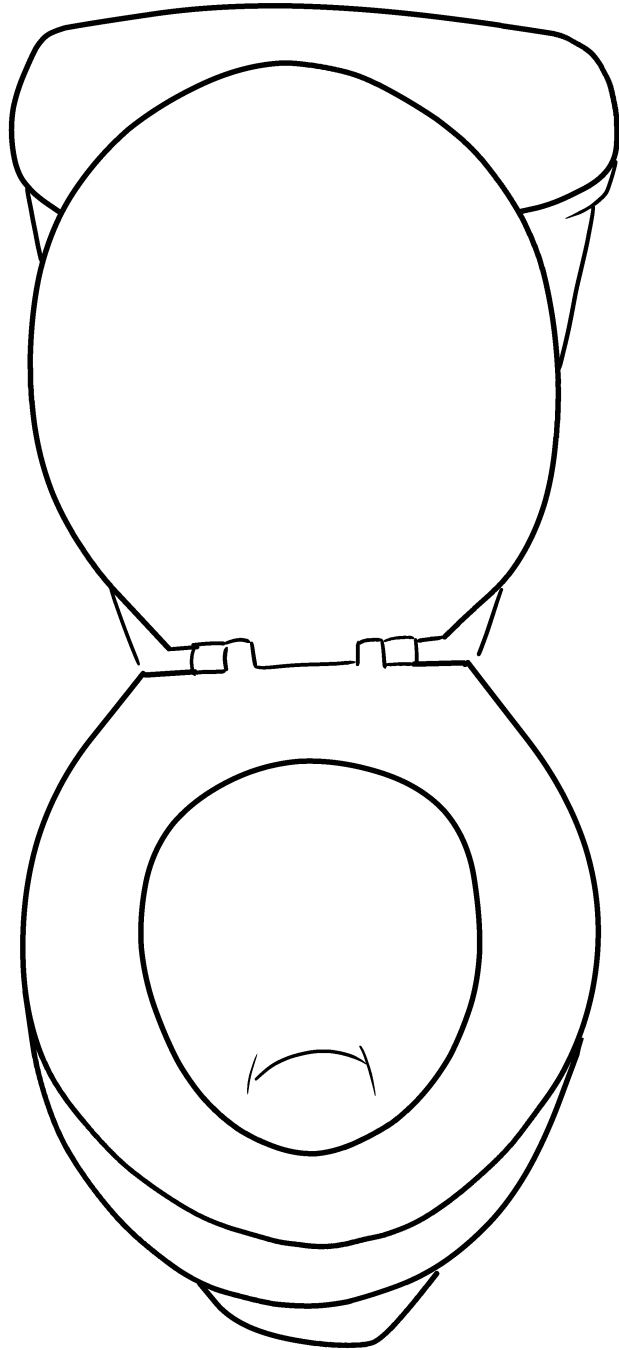

공중화장실

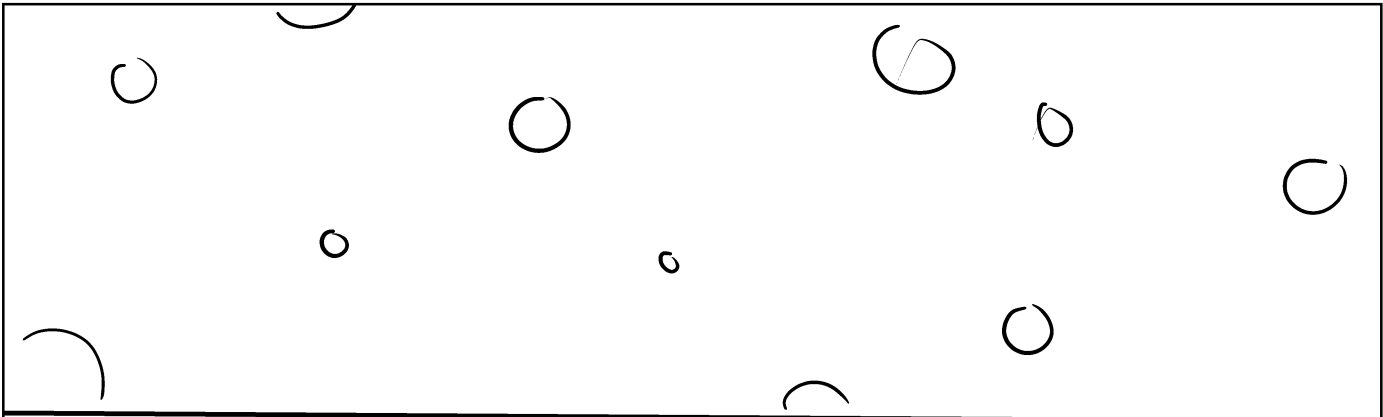

화장실의 모든 구멍이



누군가의 눈으로 보여서

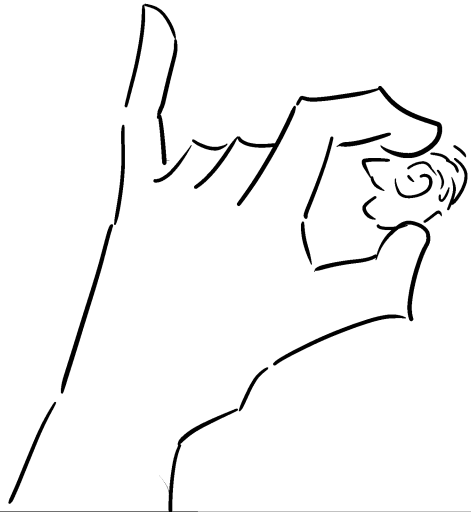

휴지로 모든 구멍을 막고

두려움에 떨며

이렇게까지 막았는데
설마 있겠어?

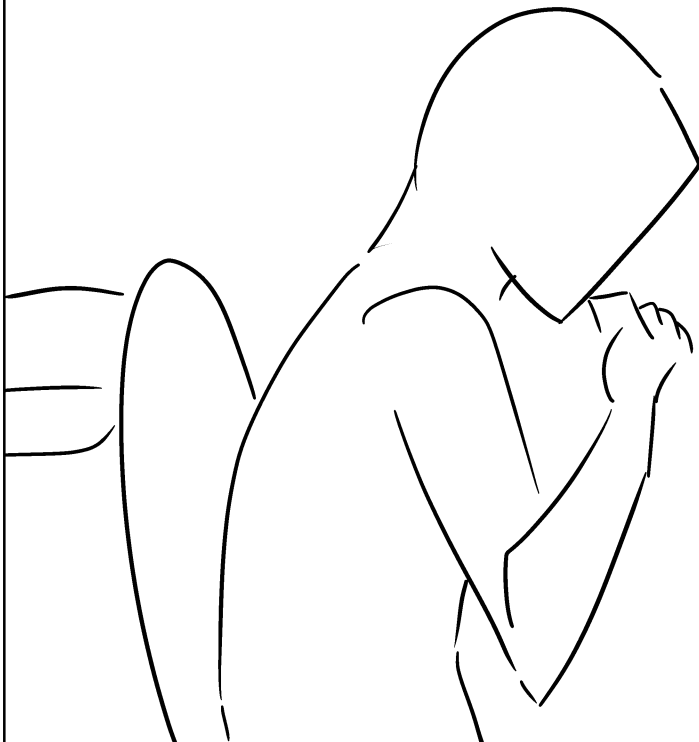

변기에 앉는다 .

또 다시
공중화장실에

갔다



무서워서 뛰쳐나왔다 .



누군가 날
보고있다는 생각에

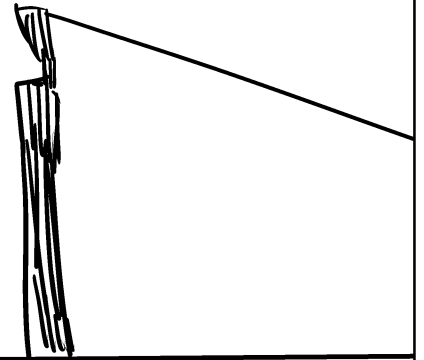

손끝부터 발끝까지
소름이 끼친다 .

여자이기 때문에



날 보는 눈을 피해
두려워하며
살아간다 .

약자들은 불안해 하며 살아가는데

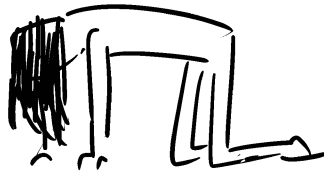

강자들은
약자들을 보고 강자라
말한다 .



여성의

성적 대상화는

일상속에

스며들어 있다 .





t v에서

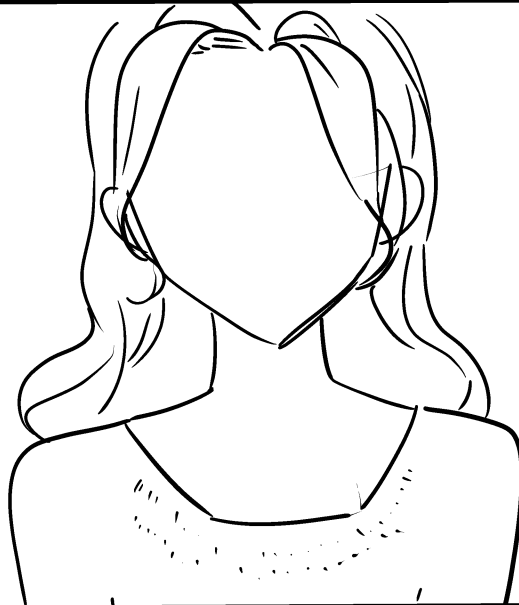

뉴스에서



주변에서



내 주변엔 너무 많은

성적대상화가
해를 끼친다.



나중에 커서
공주 될래!

여성을 성적 대상화
하는 것은



여성혐오의 일종이다 .

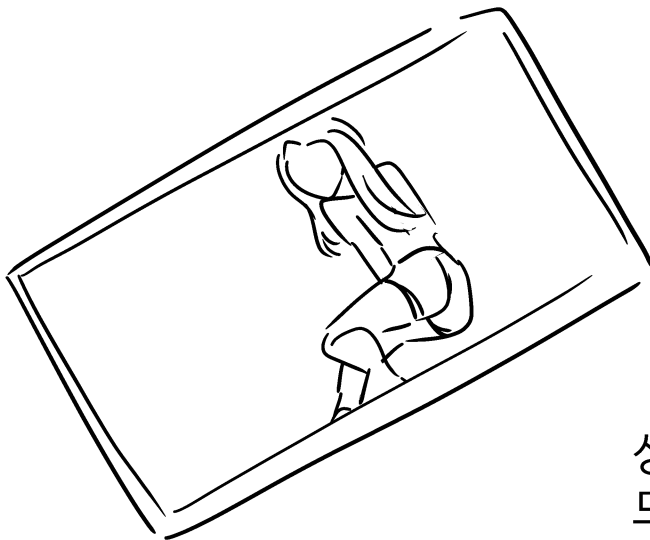

타인의
성적 쾌락을 채우기 위한
도구로 사용하는 것이다 .

여성을 물건 취급
하는 것

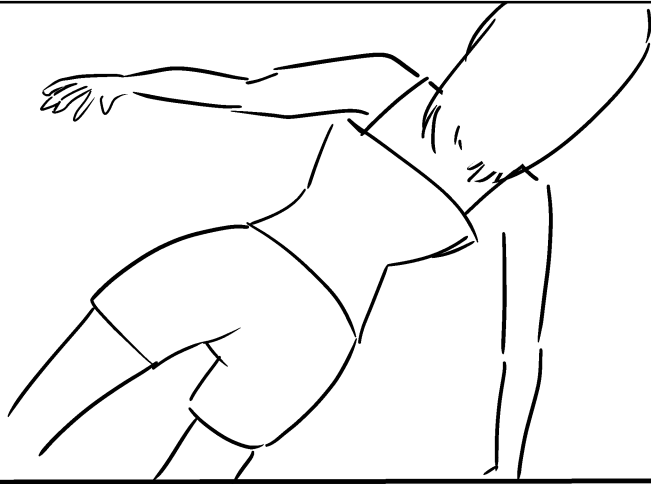

사람을 사람으로 보지 않는데

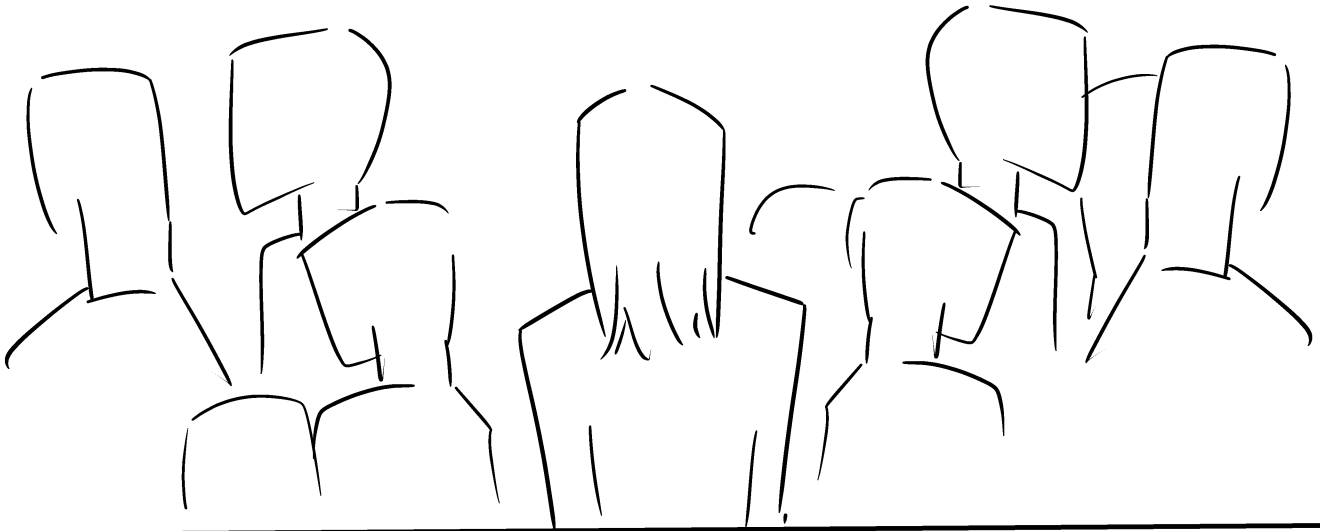

이것이 혐오가 아니면 무엇인가 .



페미니즘은
여성 참정권 운동으로
시작된 사상이다.

밑 바닥에 있던
여성의 인권을 회복시키는
사상이었다.

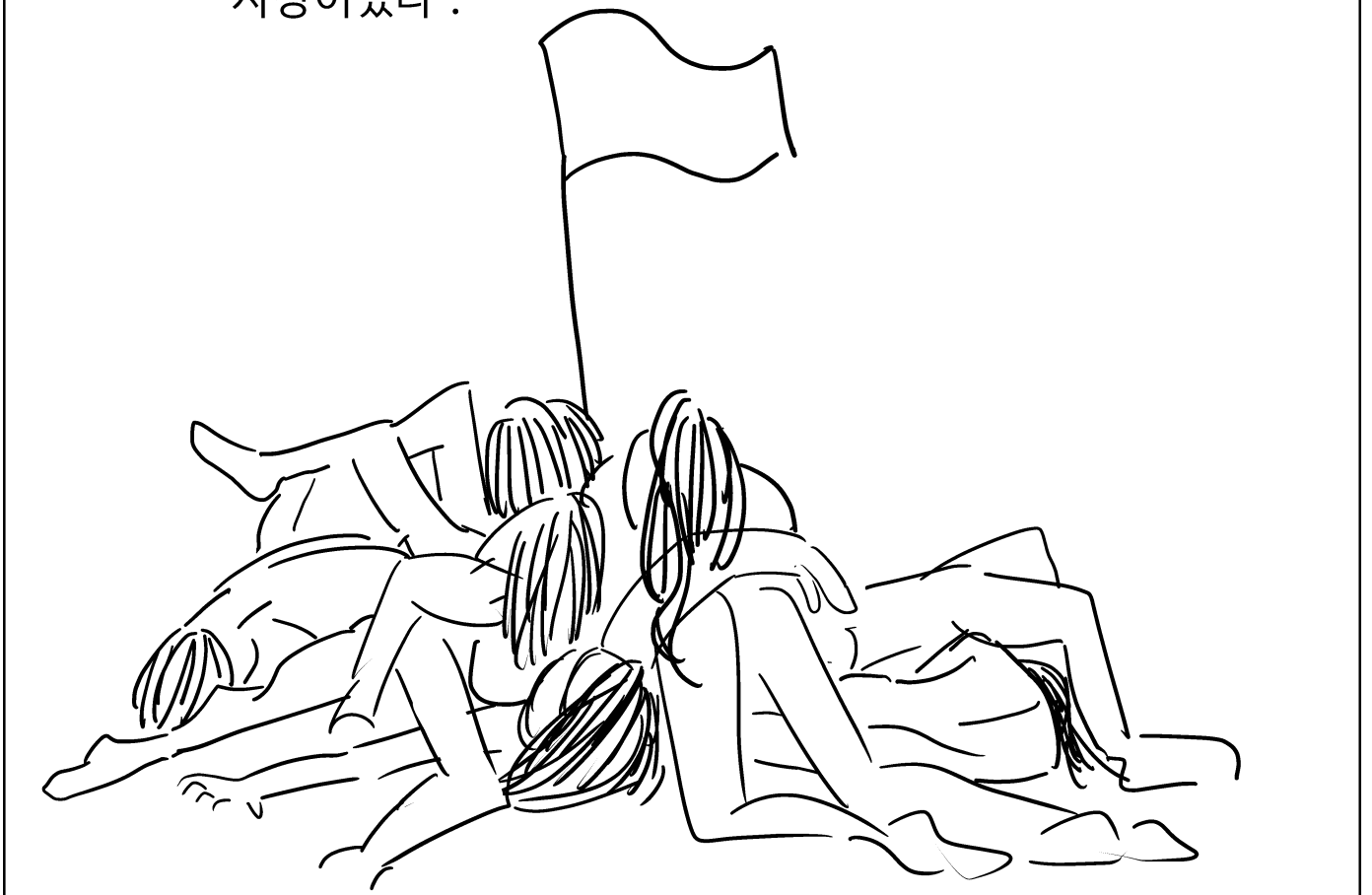



남성중심사회가



가부장제가

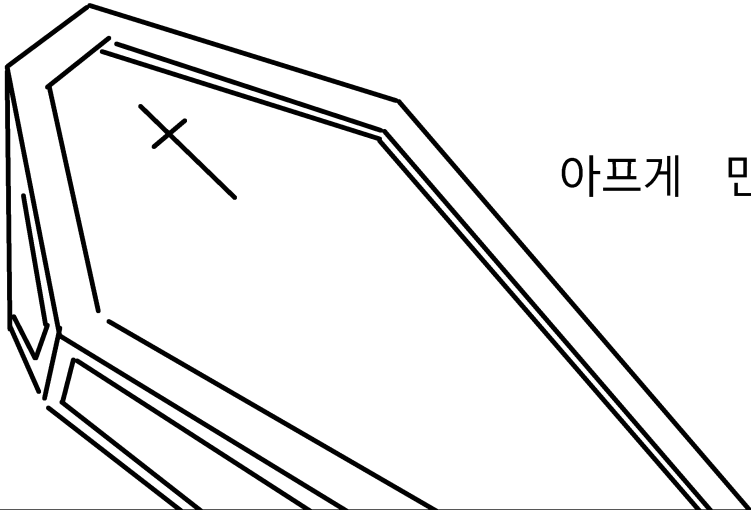

여성을

아프게 만들었다 .

여성을 인형으로 만들었고



노예로 만들었다 .



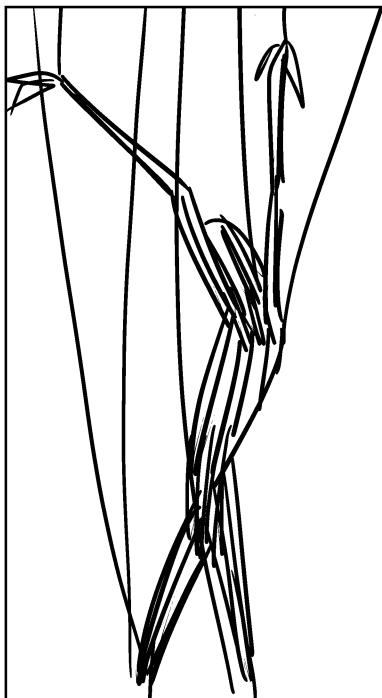

같은 사람이어도
사람 취급을 받지 못했다.



액자속 그림처럼
얌전하게 살아가면

완벽한 여성이
될 수 있다.



내가 내 삶의 주인이
되지 못한 채
살아간다.

남성에게



기대어

'여자들은 다 이러니까' 라는 생각에

이상함을



느끼지 못한다.



그가 나에게
하이힐을 신으라고 해도

화장을 하라고 해도

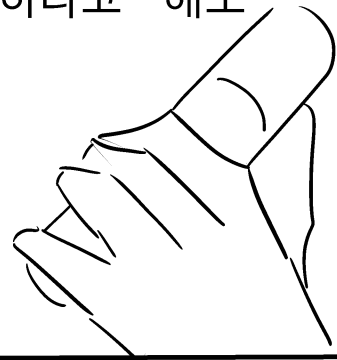

오빠는 나의
이런 모습을 가장
좋아하니까

넘겨버린다.

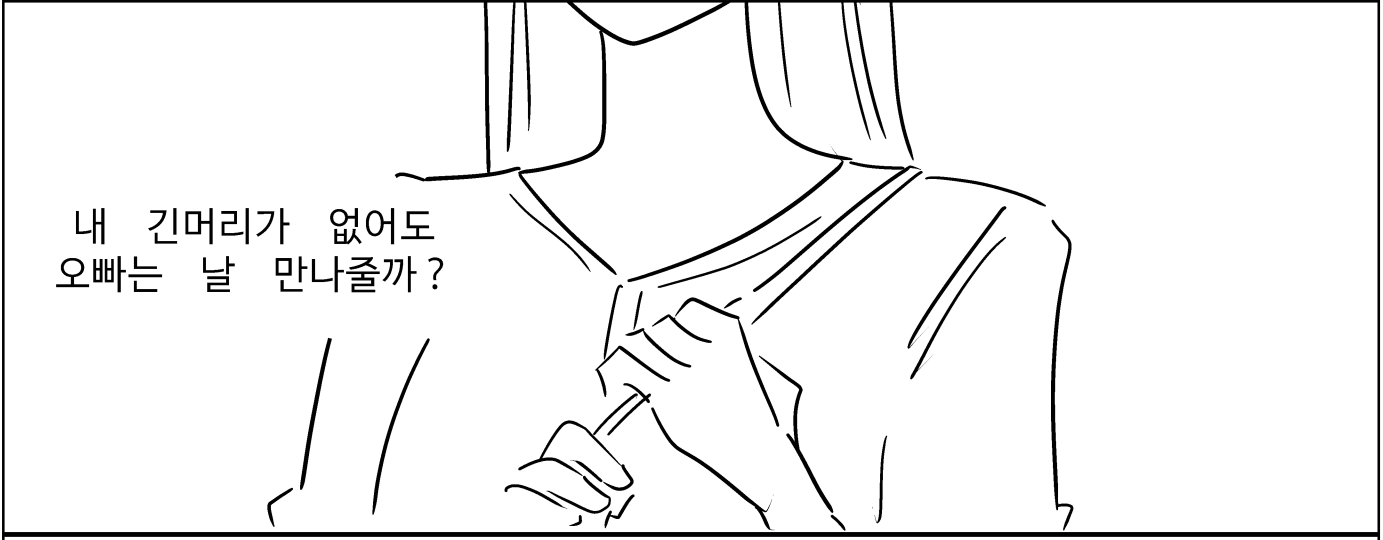

내 긴머리가 없어도
오빠는 날 만나줄까?



사랑해

너 만나주는 건
나밖에 없어



응 오빠 나도 사랑해



그의 말을 들었을 때 나는 그저
그의 인형에 불과했다는 것을 알았다.

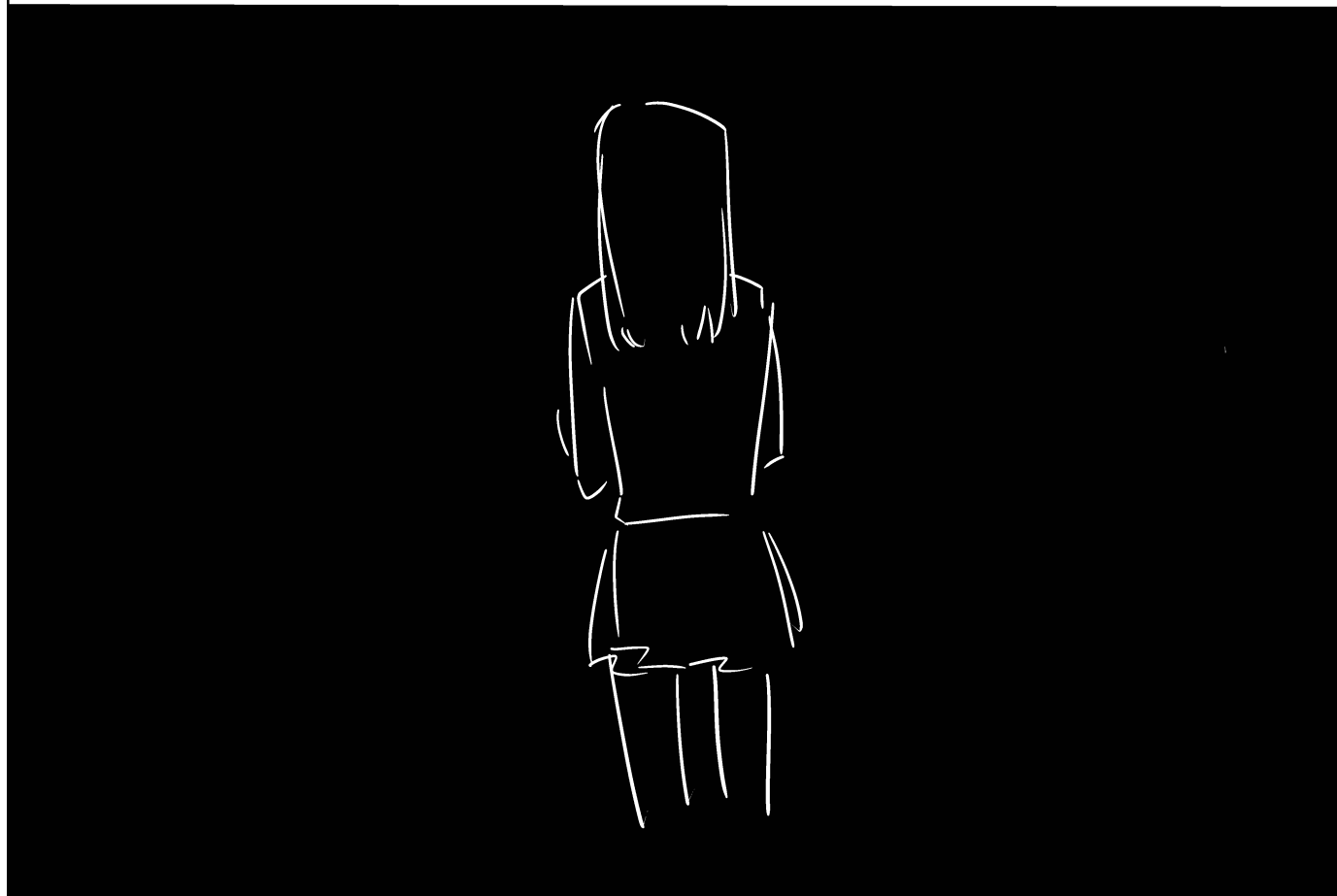



이 사회에서 여성은 누군가 지켜줘야만 살아갈 수 있다.

여성도 지켜줄 수 있는 사람이 있어야 한다.

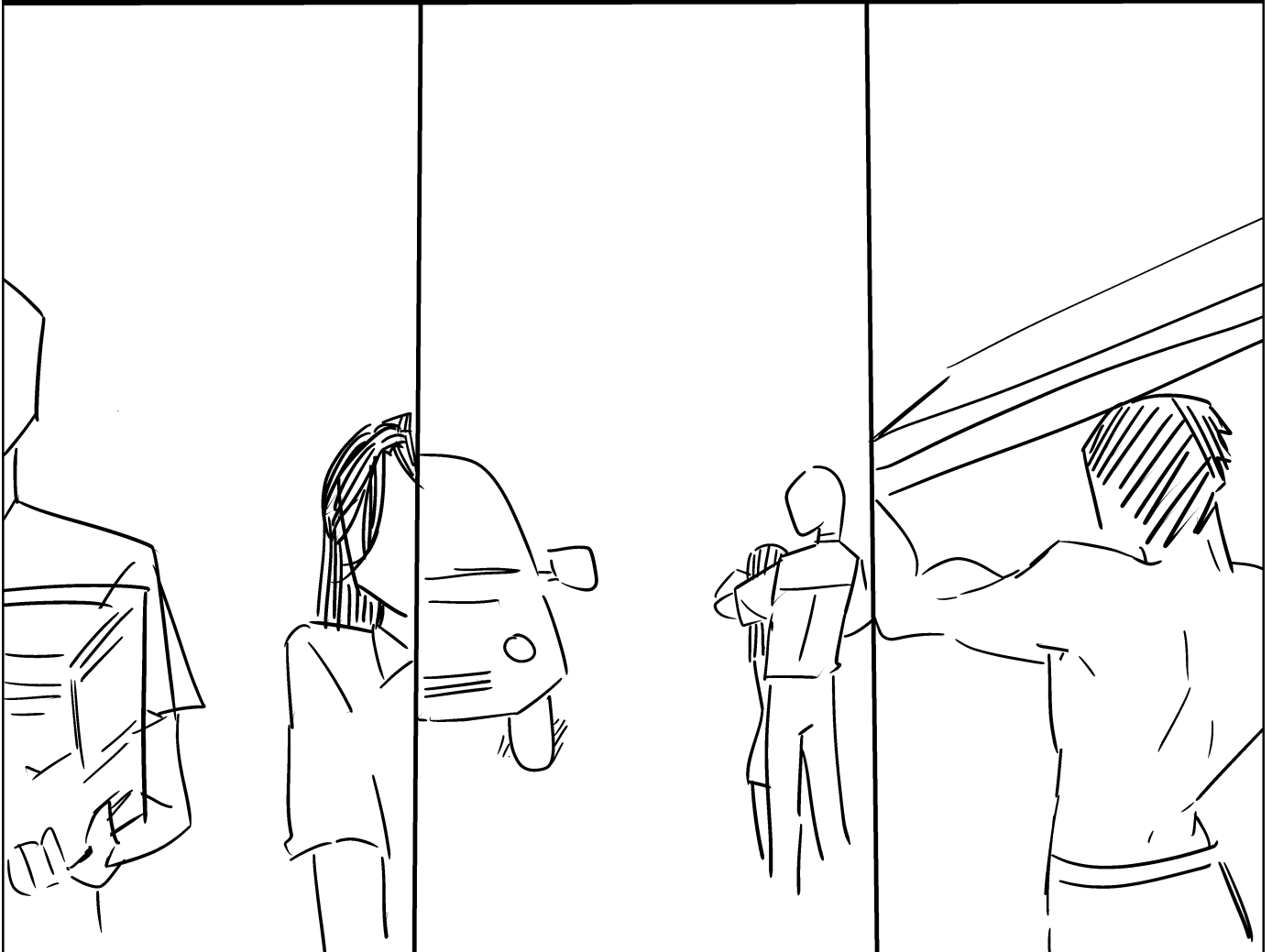

여성은



성폭력에



성희롱에



성추행에

노출되어있다 .

드라마나 영화에선
난처한 여성을
남성이 구해준다.



하지마세요 ! 라고 하면 될 것을



왜 말하지 못한거지

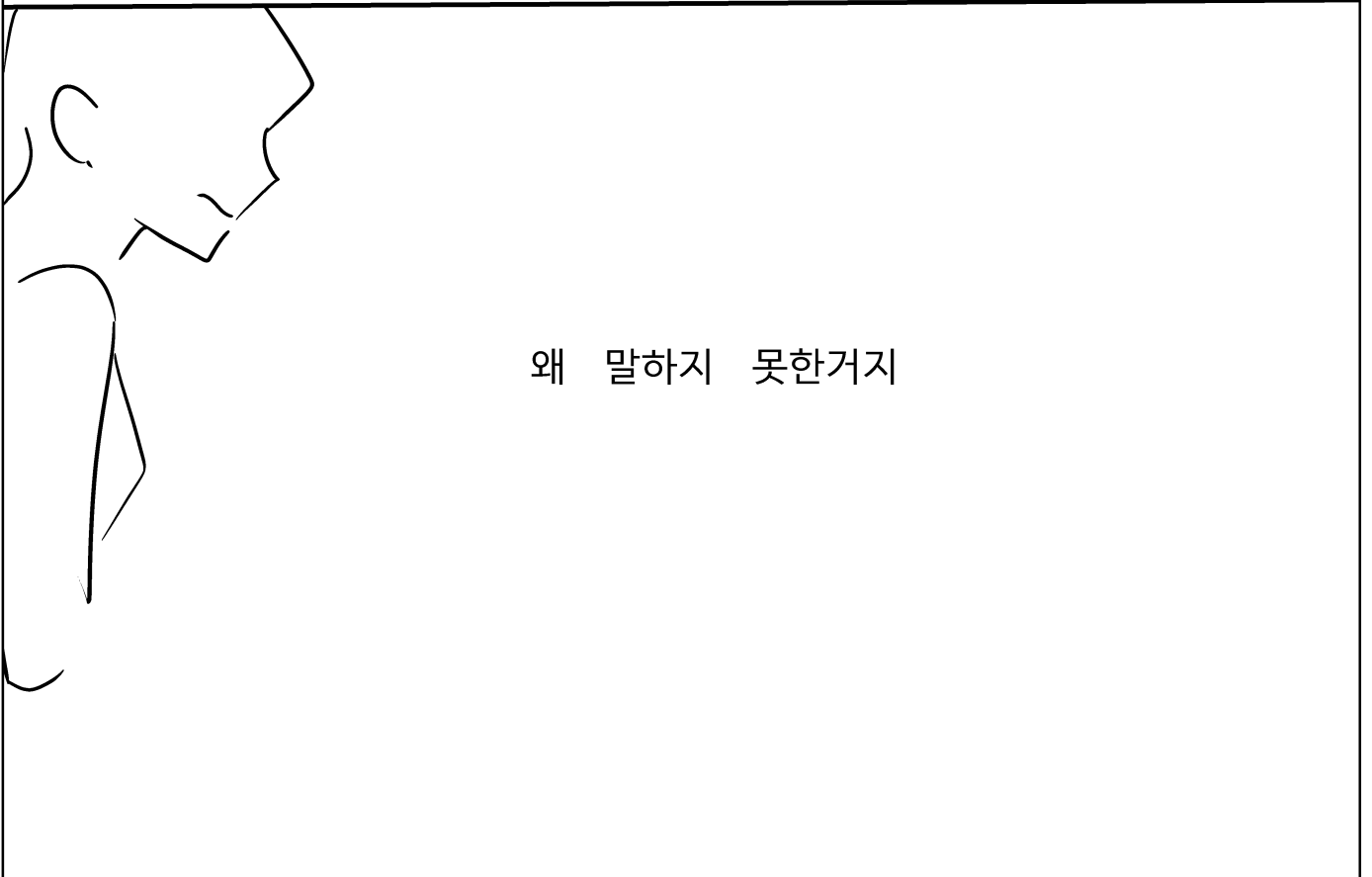

그 상황에서



지금 이거
성희롱이에요!
하지마세요.

라고 말해봤자

돌아오는 말은



뭐?
아~ 요즘 애들은 너무 민감해!!
무슨 마트?? 그런거야? 내가 뭐
범죄 저질렀어?

아무리 소리내어도



귀기울여 들어주는 사람은
단 한명도 없다.

페미니즘이 나쁜 사상으로
인식된다.

feminism

페미니스트를 메갈, 꿀페미 등등
비하하는 단어로 부른다.

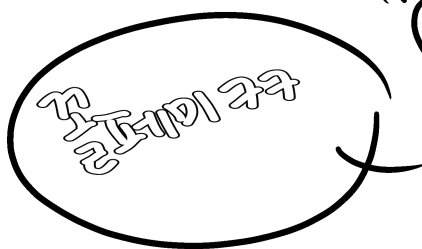

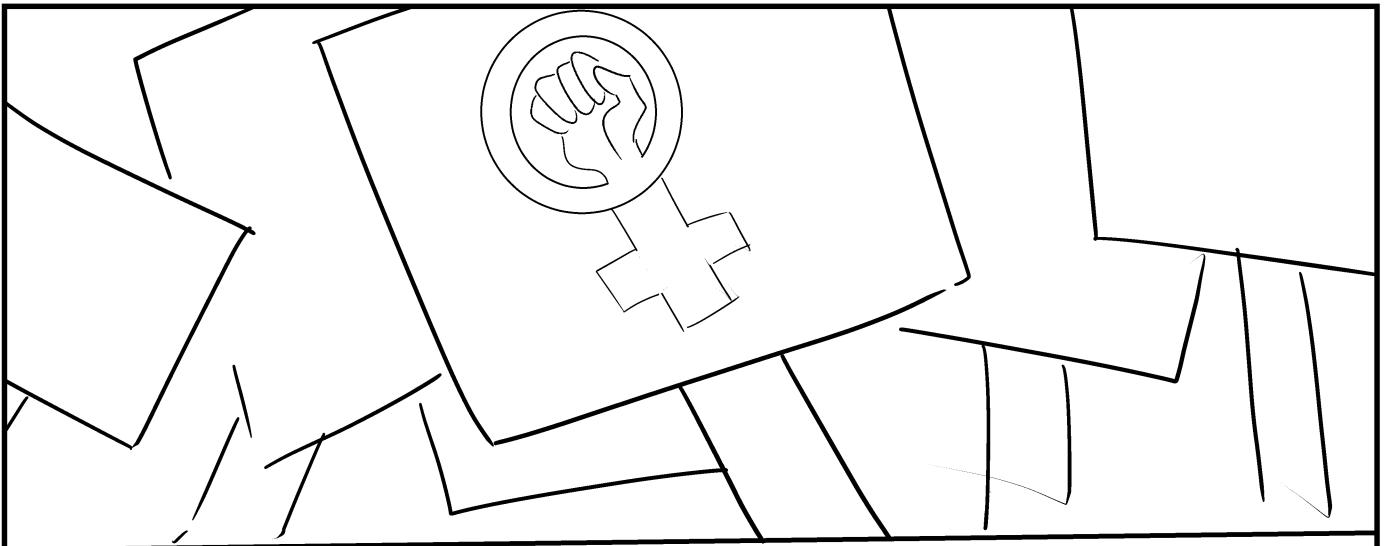

페미니즘이
대중화 된다면

여성에게만

이득이라고 ?



페미니즘은

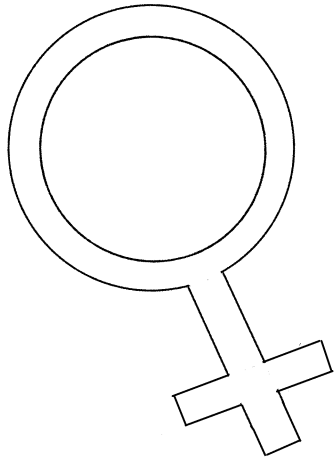

여성성과

사회적

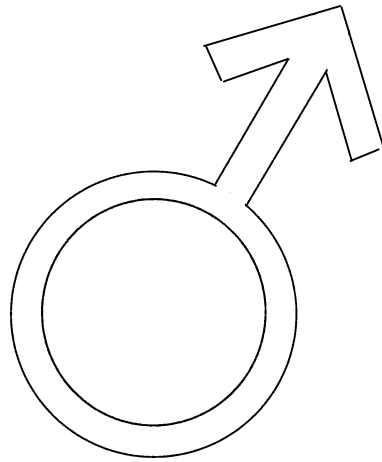

남성성을

깨부순다 .

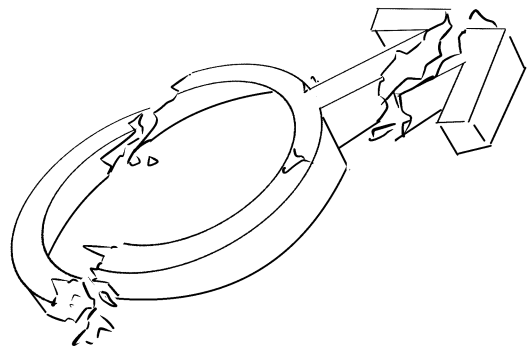
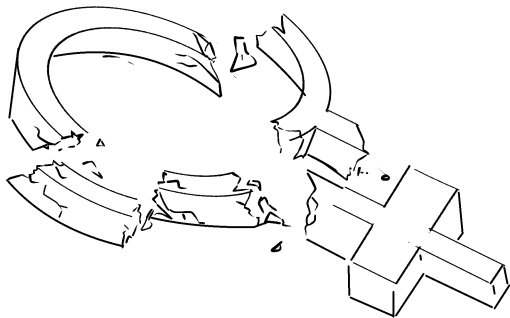

여자라는 무게와
남자라는 무게가

무너지게 하는 것이
페미니즘이다 .

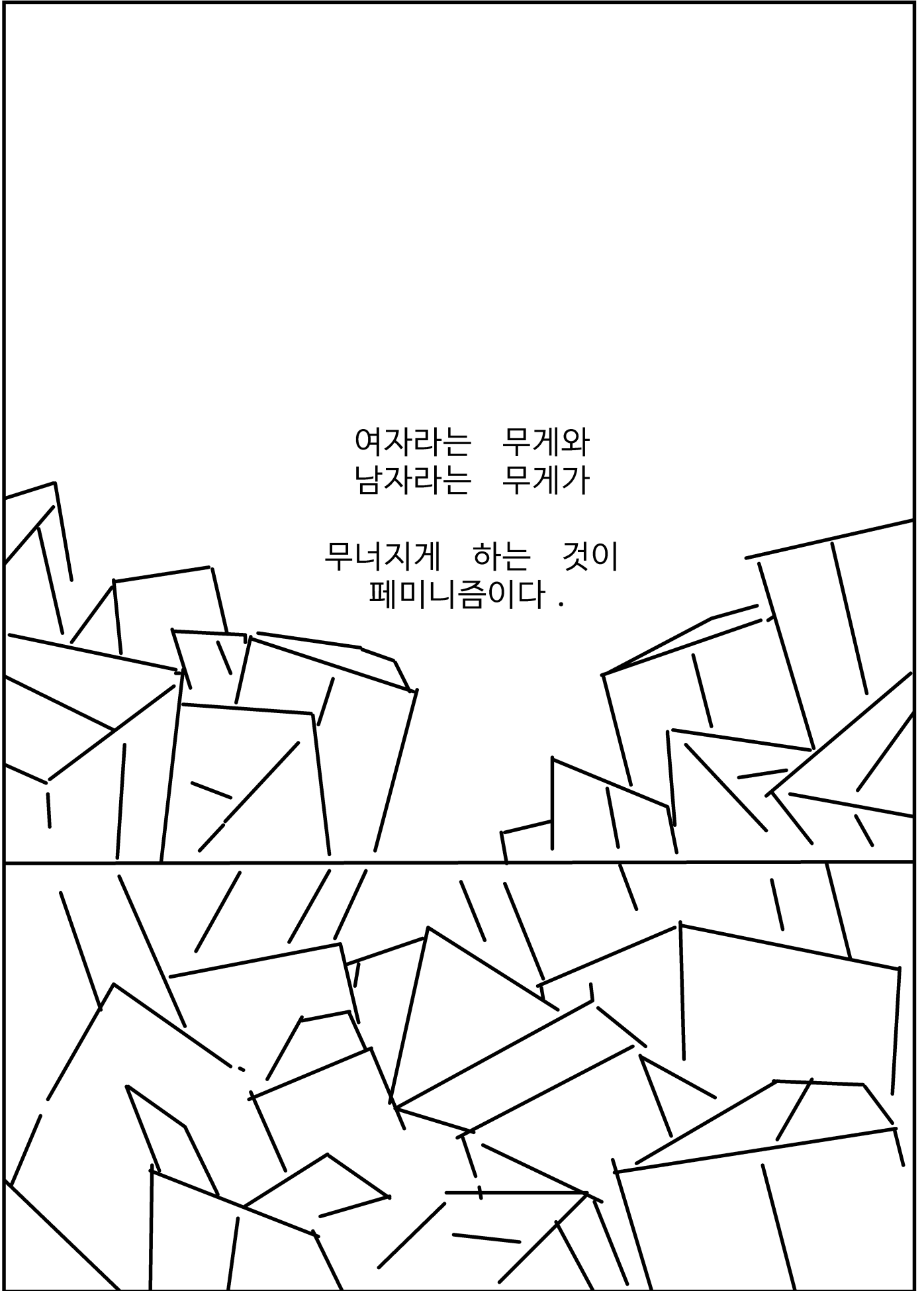

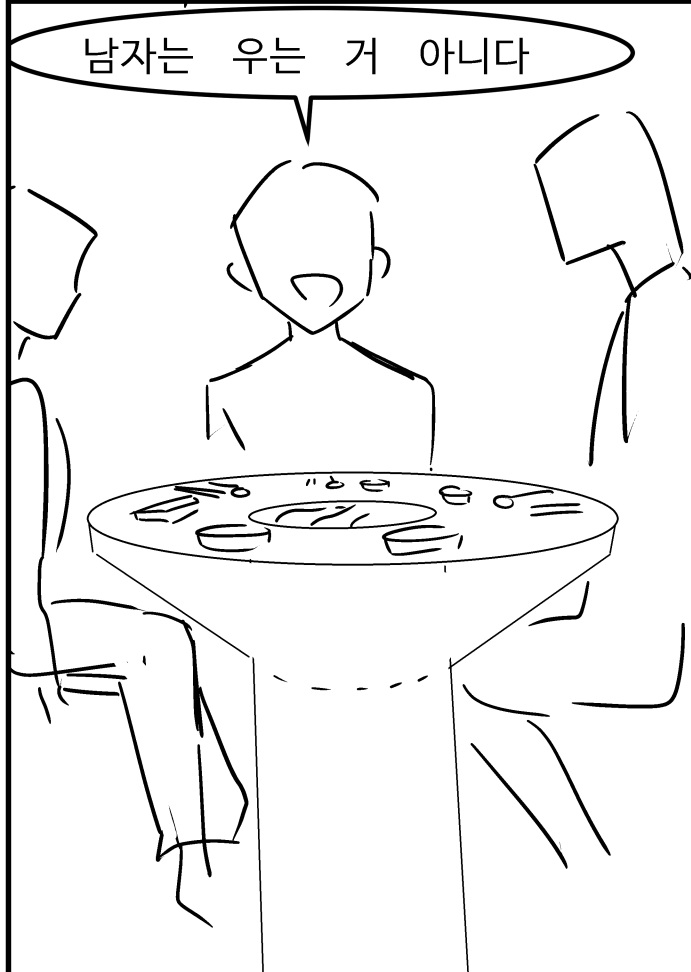

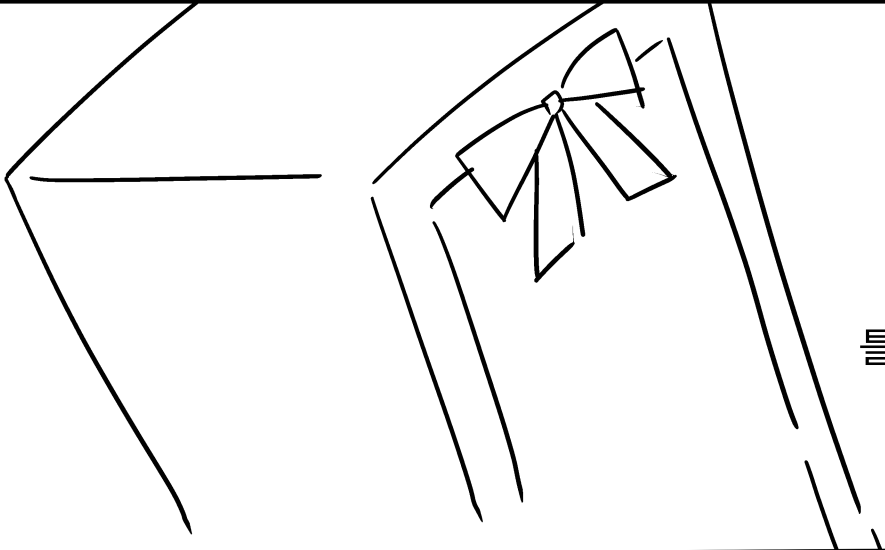

여성이란
틀이 없고

남성이란
틀이 없으면



내가 어떤 모습이든
널 사랑할 수 있으면

언제나 행복할 수 있을 것 같다 .

혼자서 감당해야
하는 것을



둘이서 나누고



여럿이서 나눌 수 있도록,

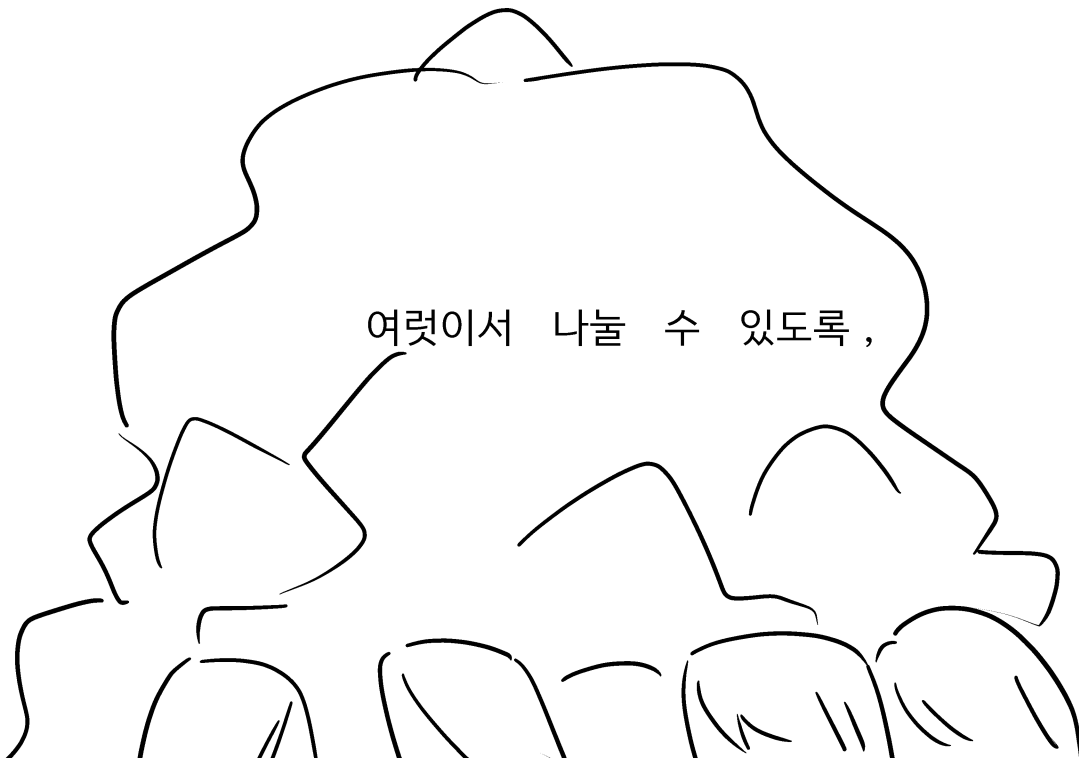

페미니즘은

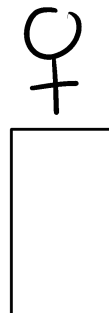

동등하게
만드는 것이
페미니즘이다.

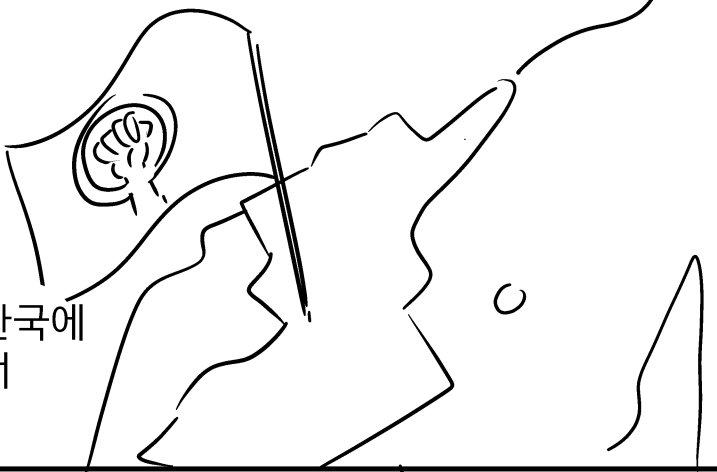

페미니즘이 한국에 정착하면서

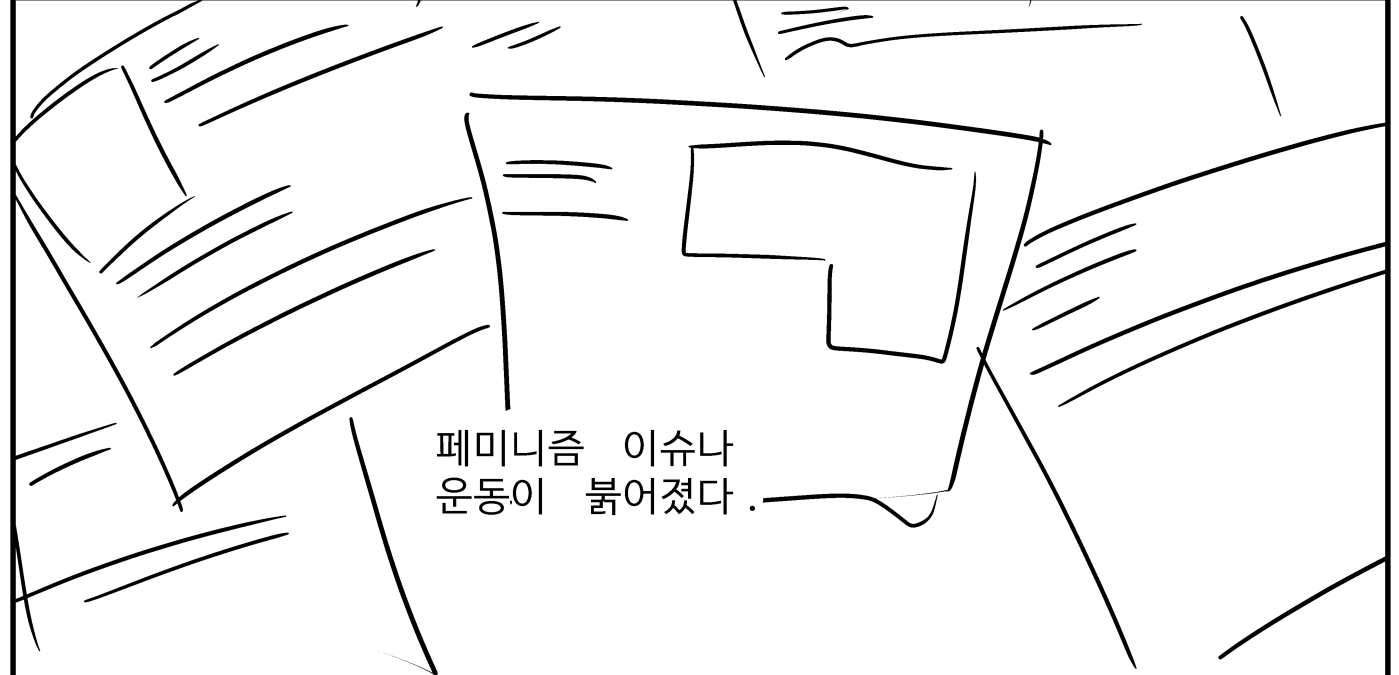

페미니즘 이슈나 운동이 불어졌다.



점차 한국도 성평등이 이루어졌다.

남성은 평등해지는
것에 대해 불만이
생길 수 밖에 없다

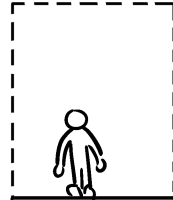

원래 가지고 있던 것이
더 많았기에

양보하는 게 더 많다

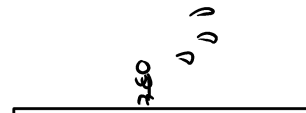
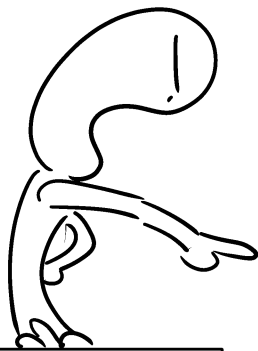



여성이 부당했다고
생각하는 걸 남성이 나눠가지고

남성이 부당하다고
생각하는 걸 여성이 나눠가지고

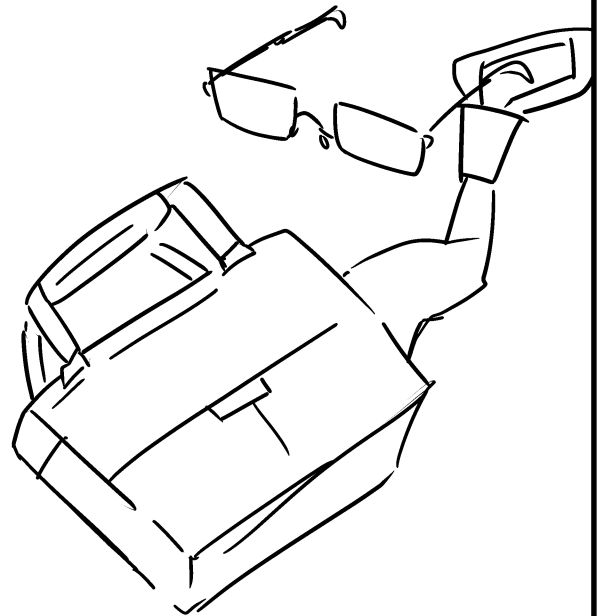

이것이 페미니즘이라고 생각한다 .



한국의 페미니즘은

폭력적이다 .

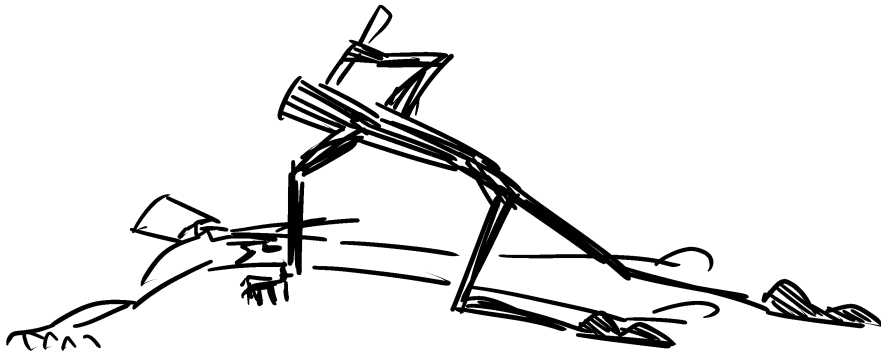

운동은 폭력적이지만

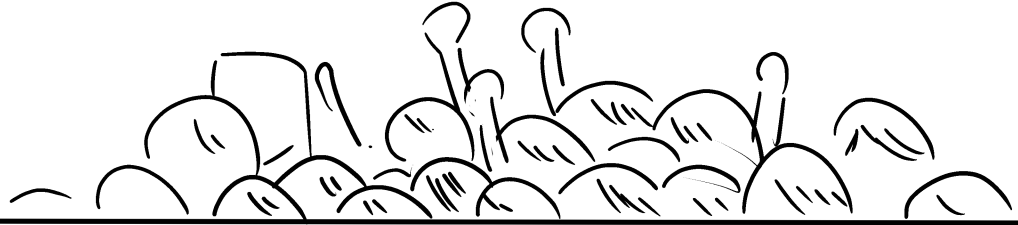

제 3자 마저 무서워하는
사상은 도가 지나칠 정도로



폭력을 행사하고
있다는 것 아닐까?

내 주변에 많은 사람들이 페미니즘을 무서워한다 .

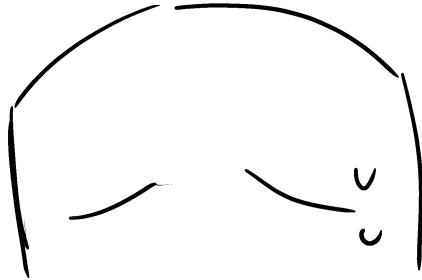

남성혐오적이고

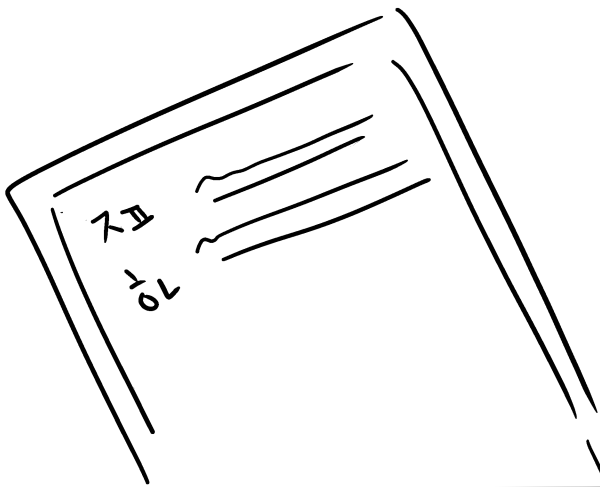

꺼려한다 .



폭력적이어서

남성이 부당하다는 이야기를 하는 것이 아닌
굳이 페미니즘에 남성혐오가 필요할까? 를 이야기를 하고 싶다 .

페미니즘이란 이름으로
남성혐오를 합리화 하는 것은
이미 페미니즘이 아니다 .

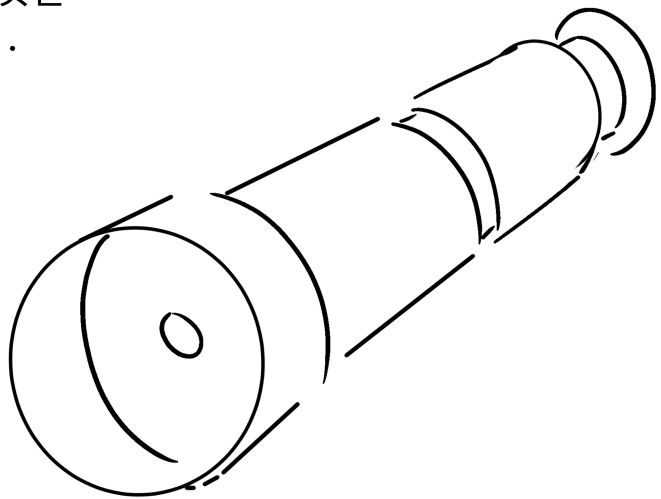

페미니즘이라는 이름으로
남성혐오를 하는 것이
페미니즘이 맞나?



그저

혐오일 뿐 아닐까?

페미니즘이 혐오화 되지 않았으면 좋겠다 .

여성과 남성에게
그리고 또 다른 성들에게

도움이 되는

사상이면 좋겠다 .



'성역할'이라는 꼭 매인 허물을 벗어



나를 찾을 수 있게

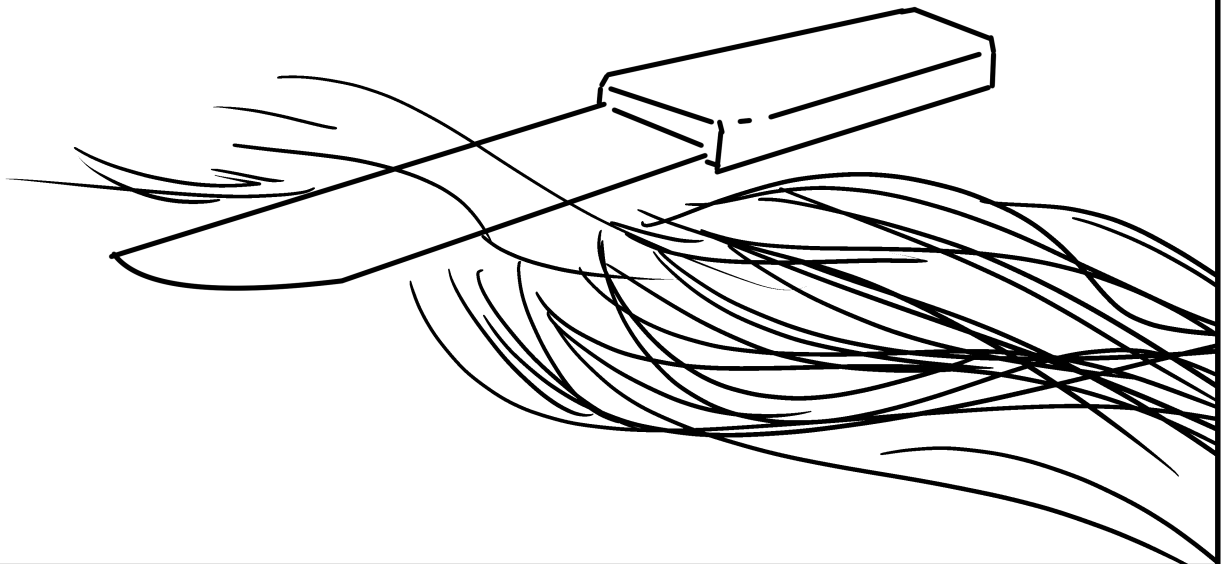

남자가 연락해도



여자가 강해도



이상하게 보아선 안된다 .

페미니즘은 여성인권에서 더 나아가

다양성을 인정했다 .

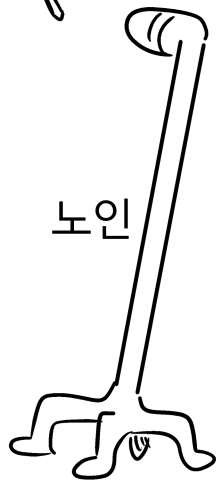
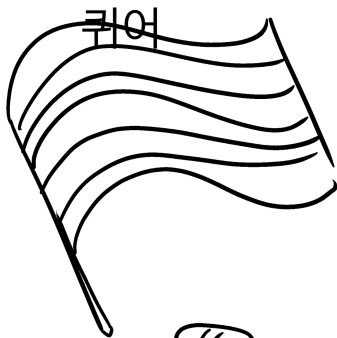
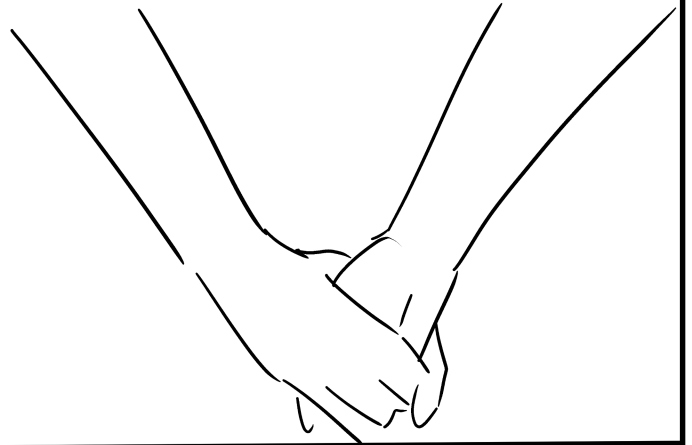

다양성을 다룬다

페미니즘은 서양에서
시작되었기에

페미니스트 내에서도

차별이 있었다 .

평등을 외치는 사상이



어떻게 그들을
외면할 수 있을까.



우리는 모두를 위한 페미니즘을 외쳐야 한다.



남자도 외칠 수 있는

페미니즘이 있어야 한다



퀴어도 외칠 수 있는

페미니즘이 있어야 한다 .

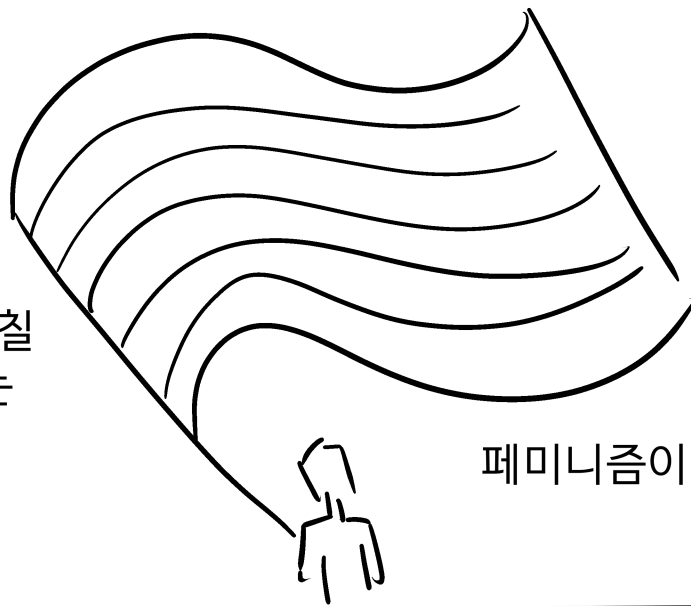

모두가 외칠 수 있는

페미니즘이 있어야 한다 .

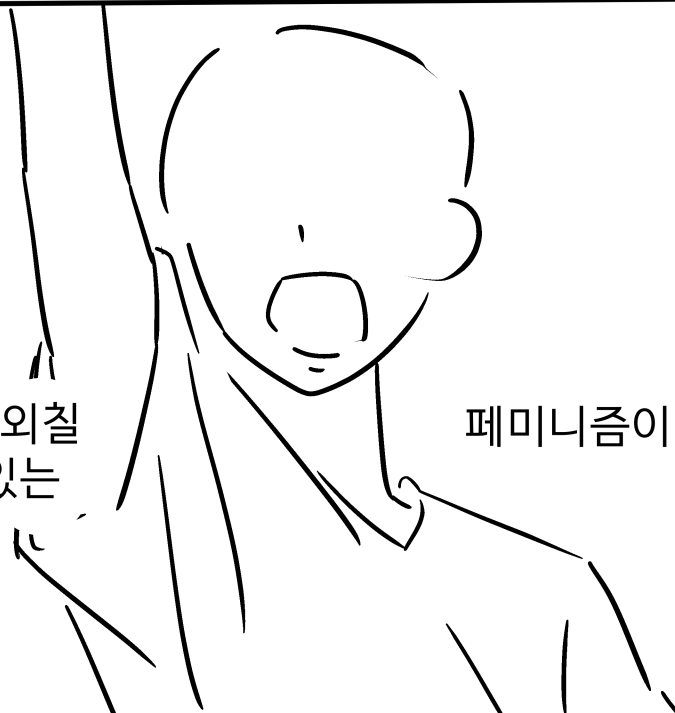

남성혐오가
없어져야 하고

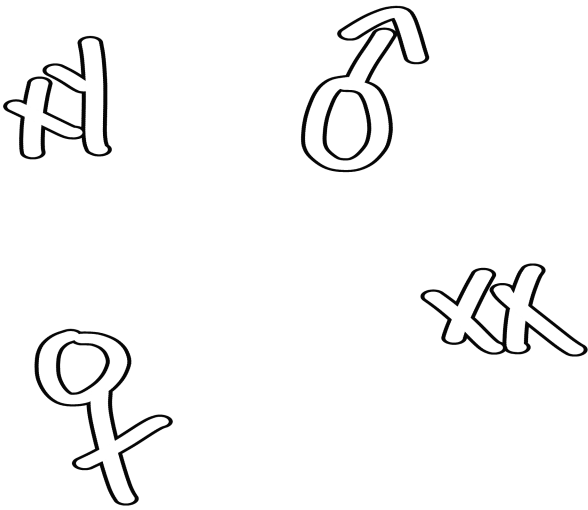
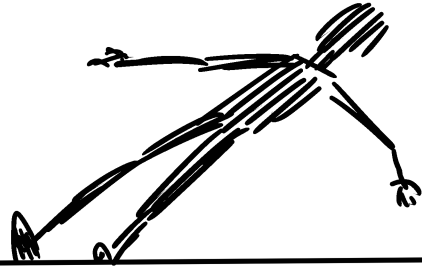

생물학적 성으로
사람을 배척하는 것을
그만두어야 한다.

페미니즘이 호감적인
사상으로 바뀌는
한 걸음이 될 것
이라고 생각한다.



사회로 바라보는 페미니즘이

무섭고, 마주보기 힘들어도



누군가에겐 도움이 되는 사상임을
알아주었으면 한다 .

여러분은
페미니즘을
어떻게
생각하시나요 ?



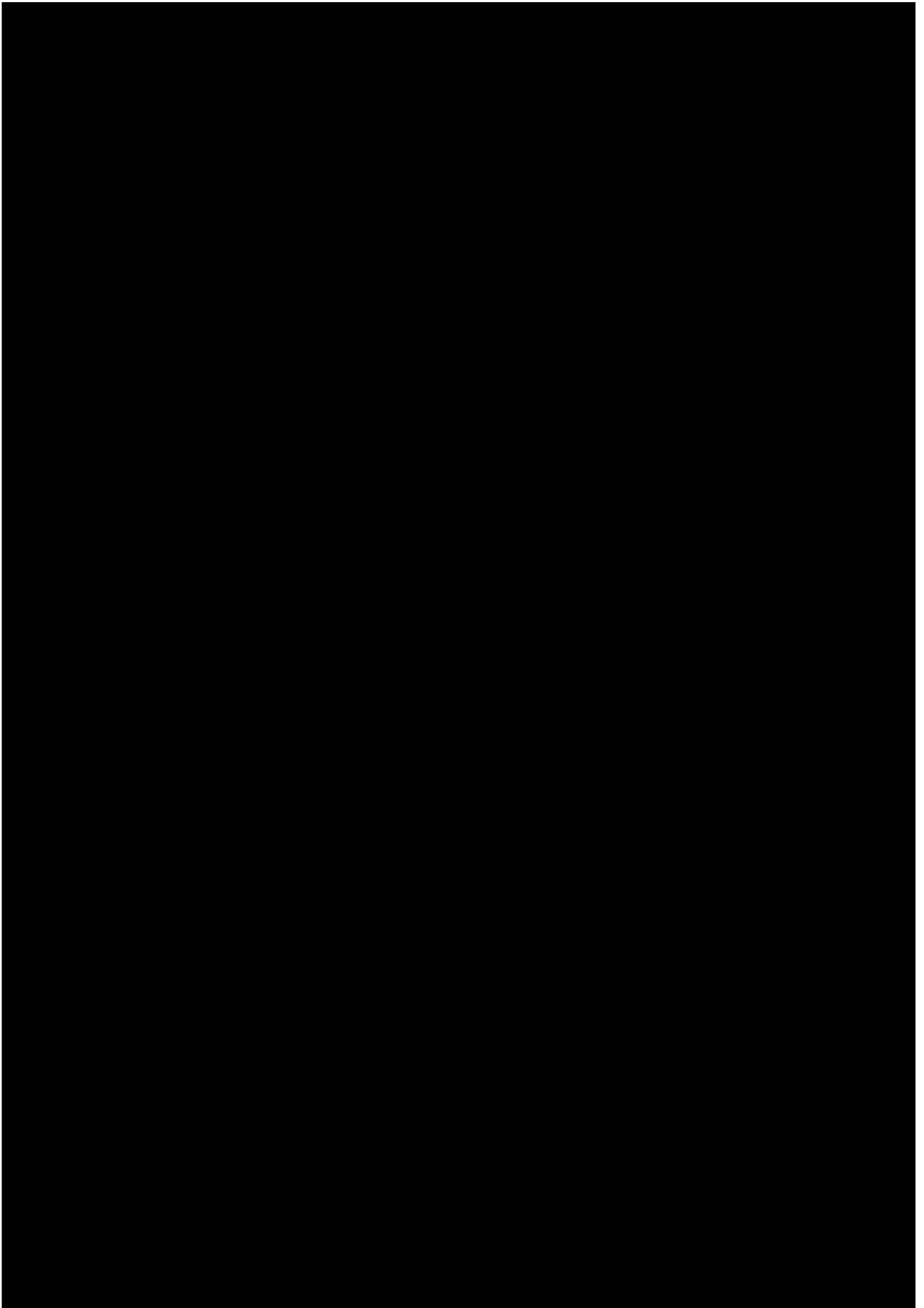

거울

2022년 10월 22일 발행

지은이 정서연

편집 디자인 정서연

정서연 2022

이 책의 일부 또는 전부를 재사용 하려면
반드시 저자와 협의 하여야 합니다.

